

OPERATING INSTRUCTIONS



OM 503T

6-DIGIT PROGRAMMABLE INSTRUMENT

STRAIN GAUGE DISPLAY



Outstanding Measurement Value...

SAFETY INSTRUCTIONS

Please read the enclosed safety instructions carefully and follow them!

Installation, all operational interventions, maintenance, and servicing must be performed by qualified personnel and in accordance with the enclosed information and safety regulations.

The manufacturer is not liable for damage caused by incorrect installation, configuration, maintenance, and servicing of the device.

The device must be installed correctly depending on the application. Incorrect installation may cause malfunction, which may result in damage to the device or an accident.

The device uses dangerous voltage that can cause fatal accidents. Before troubleshooting (in case of malfunction) or disassembling the device, it must be disconnected from the power supply. For safety information, EN 61 010-1 + A2 must be observed.

When removing or inserting the card, observe the safety instructions and follow the recommended procedure. When working on the device, it must be disconnected from the power supply.

Do not attempt to repair or modify the device yourself. A damaged device must be dismantled and sent to the manufacturer for repair.

These devices should be protected by separate or shared fuses (circuit breakers)!

The device is not intended for installation in potentially explosive atmospheres (Ex environments). Only use the device outside of potentially explosive atmospheres.





TECHNICAL DATA

OM 503 series devices comply with EU Regulations 2014/30/EU and 2014/35/EU

Complies with the following European standards:

EN 61010-1	Electrical safety
EN 61326-1	Electrical measuring, control and laboratory equipment - EMC requirements „Industrial area“
EN IEC 62003:2021	Nuclear facilities - EMC requirements for electrical equipment important for safety
EN IEC 63000	RoHS
EN IEC/IEEE 60980-344	Seismic qualification for nuclear equipment
EN 60068-2-6 ed.2:2008	Mechanical resistance - vibration

The device is suitable for unrestricted use in agricultural and industrial areas.

 DANGER 	 WARNING 	 CAUTION
DANGER OF ELECTRIC SHOCK - Before performing any service work, disconnect all power supplies and other supply lines. Failure to follow this instruction will result in death or serious injury.	DANGER OF EQUIPMENT OPERATION - Do not use this product in a safety -critical system - Do not disassemble, repair, or modify the product - Do not use the product outside the recommended operating conditions Failure to follow these instructions may result in death, serious injury, or damage to the equipment.	DANGER OF EQUIPMENT OPERATION - Install the required device protection Failure to follow this instruction may result in injury or damage to the equipment.

Electrical equipment may only be installed, operated, maintained, and serviced by qualified personnel. ORBIT MERRET accepts no responsibility for any consequences arising from the use of this material.

1. CONTENTS	3
2. DESCRIPTION OF THE DEVICE	4
2.1 Description	4
2.2 Controls	5
2.3 Options	5
2.4 Meaning of LED symbols	6
2.5 Button functions	7
2.6 Turn on Bluetooth communication	7
2.7 Setting of numbers and decimal point	7
2.8 Block diagram of the measured signal processing	8
2.9 Symbols used in this user manual	8
3. CONNECTING THE DEVICE	10
3.1 Connecting measuring in inputs	12
3.2 Connecting analog outputs	13
3.3 Connecting data outputs	13
3.4 Connecting relay/OC outputs	14
3.5 Connecting external control inputs	15
3.6 READY output	15
3.7 Connecting the device to the power supply	15
4. FIRST TIME TURNING ON THE DEVICE	16
4.1 Setup guide	16
4.2 Input Setting and Calibration for load cell (strain gauge) sensors	23
5. DEVICE SETTINGS	24
5.1 Setting - INPUTS	26
5.1.1 Analog input settings	26
5.1.2 Selecting the function of external inputs	31
5.1.3 Selection of additional functions assigned to buttons	35
5.2 Setting of CHANNELS	38
5.2.1 Resetting internal values	38
5.2.2 Setting of Channel A	38
5.2.3 Settings for Channel B - C	47
5.3 Setting of FUNCTION	48
5.3.1 Timer	48
5.4 Setting of OUTPUTS	50
5.4.1 Relay/OC output	50
5.4.2 Analog output	56
5.4.3 Display	58
5.4.4 Memory	64
5.5 Settings of COMMUNICATION	68
5.5.1 Data output RS 232/485	68
5.5.2 Data Output MODBUS TCP/IP	70
5.5.3 Bluetooth	71
5.6 Setting of SERVICE	72
5.6.1 Setting a password for accessing the device menu	72
5.6.2 Setting the delayed start of the device	73
5.6.3 Saving user settings	73
5.6.4 Loading user settings	73
5.6.5 Return to factory settings	74
5.6.6 Deleting user calibration	74
5.6.7 Date settings	75
5.6.8 Current time settings	75
5.6.9 Selecting the menu language	75
5.6.10 Selection of signaled error states	76
5.6.11 Enabling the device setup wizard restart	77
5.6.12 Input signal simulation	78
5.6.13 Displaying information about the device	79
6. USER LEVEL SETTING	80
6.0 Setting items in the „USER“ menu	80
7. DATA PROTOCOL	82
9. TABLE OF CHARACTERS	84
10. ERROR MESSAGES	85
11. TECHNICAL DATA	86
12. DEVICE DIMENSIONS AND INSTALLATION	88
13. WARRANTY SHEET	89
EC DECLARATION OF CONFORMITY	91

Trademark notice

The name ORBIT MERRET® is a registered trademark of ORBIT MERRET, spol. s r.o. and is protected by intellectual property laws within the European Union. Any use of this trademark without prior written consent of the owner is prohibited.

2. Description of the device

2.1 Description

The OM 503 series consists of 6-digit panel meters that are based on a 32-bit processor and a fast 24-bit $\Delta\Sigma$ ADC converter, ensuring high measurement accuracy and immediate response. These meters have been designed with a focus on top performance, reliability, and user comfort, making them an ideal choice for demanding measurement applications.

For maximum convenience, the instruments feature a dual-line display, capacitive touch buttons with color navigation and haptic feedback, as well as an integrated setup guide that facilitates intuitive operation.

Their modular design allows easy customization of functions, while the focus on serviceability ensures long lifespan and low maintenance costs.

The OM 503T model is a display unit for load cells, equipped with advanced weighing functions. It has been designed to ensure accurate and reliable measurements and to enable easy processing of signals from load cell sensors.

INPUT CALIBRATION

Sensor based	enter the technical parameters of the sensor > sensitivity, nominal range
With load (live)	two-point calibration with reference load > min, max, and nominal range
Accor. to el. values	enter the elect. parameters of the measurement range in mV/V > min, max, and nominal range
Display range	-.99999...999999

SENSOR EXCITATION

Fixed	10 VDC, load $\geq 80 \Omega$, optionally 5 VDC
-------	--

WEIGHING FUNCTIONS

Zero tracking	keeps the display stable at "0" value even if there are slight signal fluctuations
Automatic tare	compensates for the residual negative weight of the weighing system
Division size	defines the smallest step by which the displayed value can change
Equilibrium state	indicates that the measured value is stable and within permissible deviation limits

DIGITAL FILTERS

Floating point / Exponential / Arithmetic average	of 2...100 measurements
Rounding	display step setting for the display
Network IIR filter	filter selection for network hum suppression

MATHEMATICAL FUNCTIONS

Linearization	non-linear signal is converted using up to 100-point linear interpolation
Tare	zeroing of display while the input signal is not zero
Offset	fixed shift of the initial value
Min/max. value	registration of min/max values achieved during measurement
Peak value	display shows only the highest or lowest measured value
Math. functions	polynomial, 1/x, logarithm, exponential, power, square root
Simulation	the device simulates its function without a connected input signal
Logging	recording of events and error messages with time stamp

EXTERNAL CONTROLS

Hold	stops measurement
Lock	locks buttons
Tare	Tare activation and reset
Min/Max reset	reset Min/Max value
Peak reset	reset Peak value
Hold Min/Max/Avg	measurement of Min/Max/Avg values
Sample	start of single measurement
Data recording	saving measured values to the device memory
Opening limits	enabling relay opening in Continuous mode (safety relay)

2. Description of the device

2.2 Controls

The device is controlled and set using five touch buttons located on the front panel. For better orientation in the menu, the buttons are color-backlit and equipped with haptic feedback.

The initial setup of the device can be easily performed using the Wizard, which will guide you step by step through the basic settings required to start the device.

PRO Complete programming menu

- contains the complete device menu and is protected by an optional numeric code

USER User programming menu

- can contain selected items from the PRO menu, access is without a password

The device settings can be easily configured using the OM Link SW from a PC via USB-C or Bluetooth.

The program allows archiving of settings, firmware updates, and expands the device's functions in the following areas:

- entering the linearization table
- exporting recorded measurement data (optional, internal memory is a separately ordered feature)
- viewing of saved logs and events
- device calibration

All settings are stored in EEPROM memory, so they are retained even after the device is turned off.

2.3 Options

Comparators are designed to monitor two, three, four, or six limit values with relay or OC output. The user can choose from various modes and output functions to suit specific operating requirements. When the set limit values are reached, this is indicated by an LED signal and simultaneously by the switching on/off of the corresponding output.

Data outputs are, thanks to their speed and accuracy, ideal for transferring measured data to other display devices or directly to control systems. Isolated RS232 and RS485 interfaces are available with support for ASCII, Modbus, PROFINET, and EtherCAT protocols.

Analog outputs are ideal for applications where further evaluation or processing of measured data in external devices is required. A universal analog output is available with a choice of type and range – voltage or current.

Recording of measured values is ideal for applications requiring time-dependent data monitoring and storage. Recording is controlled by real-time clock (RTC), with the option to set storage at defined time intervals and periods, or in the case of short-term events, it ensures continuous recording with high write speed. Data is stored either in the device's internal memory or on a USB-C flash drive.



Application sheets are available for products on our website www.orbitmerret.eu under the „Support Downloads“ tab, providing a detailed description of the device's features, functions, and uses.

2. Description of the device

2.4 Meaning of LED symbols

The device is set up and controlled using five buttons located on the front panel, which can be used to scroll through the control menu, select and set the desired values.

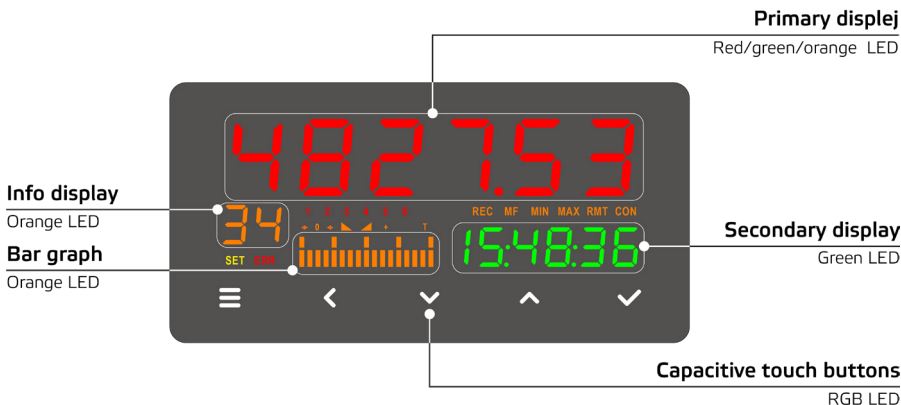





MEANING OF SIGNAL LEDES

Symbol	Function	LED color
1 2 3 4 5 6	Active relay/OC output Flashing digits indicate a limit with restriction (hysteresis, delay)	red
REC	Steady light – device is in recording standby mode Flashing – active recording to memory in progress	orange
MF	Active Mathematical functions	orange
MIN	The display shows the minimum value	orange
MAX	The display shows the maximum value	orange
RMT	The device is being remotely configured (USB)	orange
CON	Active data communication (BT, Data output, Ethernet)	orange
SET	The device is in setup mode	yellow
ERR	Error message indication + The error number is displayed on the Info display + The secondary display shows the error description	red
T	Active function Tare	orange
+	Active Linearization Table	orange
▴ ▾	Indication of a stable measured value	orange
▾	Measured values show a downward trend	orange
▴	Measured values show an increasing trend	orange
→ 0 ←	Automatic zeroing function is active	orange

2. Description of the device

2.5 Button functions

Button	Measurement	Menu	Number setting/selection
	enter PRO menu	exit menu	exit editing
	programmable button function	return to previous level	move to higher decade
	programmable button function	move to previous item	move down
	programmable button function	move to next item	move up
	programmable button function	confirm selection	confirm setting/selection

2.6 Turn on Bluetooth communication

Bluetooth communication can be turned on in two ways

- quick activation is performed by pressing simultaneously buttons  and 
- by enabling it in the device menu *COMMUN/BLUE.T/BLUE.ON/YES?*

CON flashes Bluetooth is active but not connected



CON stays lit Bluetooth is successfully connected



Bluetooth communication can only be activated if you have set a device password ($\neq 0$)

2.7 Setting of numbers and decimal point

DECIMAL POINT

Select it from the menu. When editing the number being set, press the  button to move to the highest decade, where only the decimal point will start flashing. Its placement is done using the  /  buttons.

MINUS SIGN

Set the minus sign using the  button on the upper decade.

2. Description of the device

2.8 Block diagram of the measured signal processing

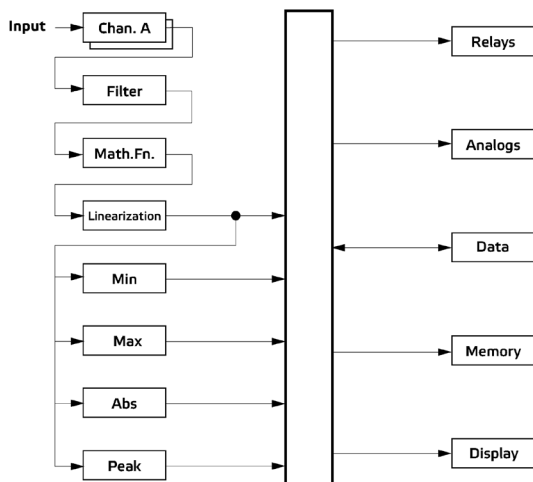

2.9 Symbols used in this user manual

DEF

Default factory settings



After pressing the button, the set value will be saved



After pressing the button, the set value will not be saved

2. Description of the device

3. Connecting the device

The power supply lines for the device should not be located near low-voltage input signals. Contactors, motors with higher power consumption, and other powerful components should not be located near the device.

The cable leading to the device input (measured quantity) should be sufficiently distant from all power cables and appliances. If this cannot be ensured, it is necessary to use a shielded cable with a ground connection (terminal E).

The devices are tested according to standards for industrial use, but we nonetheless recommend that you follow the above guidelines.

■ Wiring connections

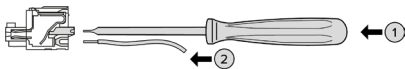

Wire	Connector pitch	3,5 mm	5 mm
Type	mm in		
Cross-selection	mm ² AWG	0,05...1,5 30...14	0,05...2,5 30...12

A cable type of wire must be terminated with a ferrule before being connected to the connector!

■ Galvanic isolation of the device

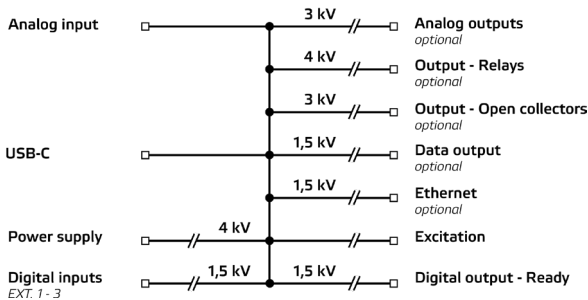

The device does not have a galvanically isolated USB-C interface. When signal inputs and USB are connected simultaneously, always use a USB isolator to connect to a PC. This will prevent ground loops, interference, and possible damage to the equipment.

3. Connecting the device

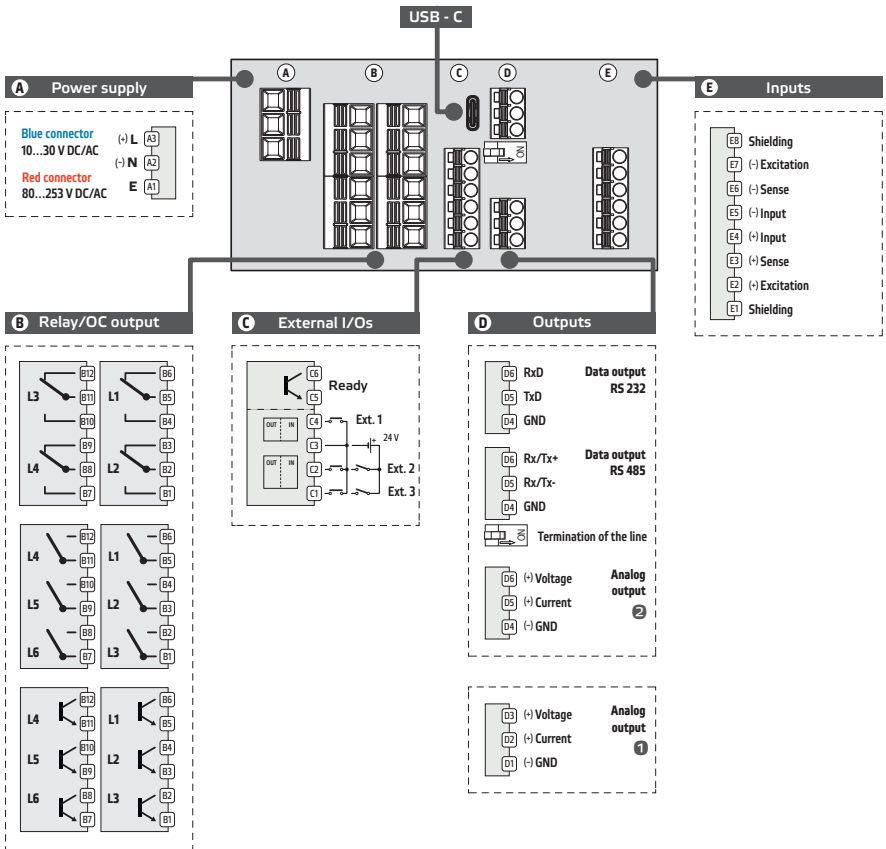

■ Modbus TCP/IP data output

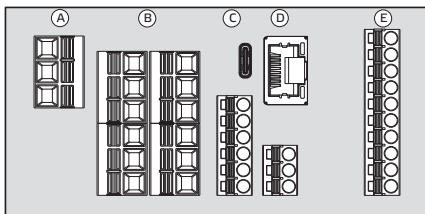

■ PROFINET/EtherCAT data output

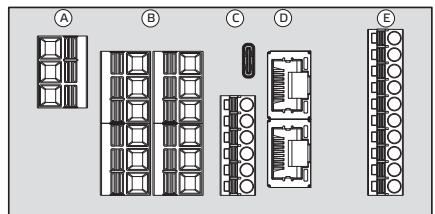

3. Connecting the device

3.1 Connecting measuring in inputs

The input signal is connected to the 8-pin connector in position E.

The input and range selection can be set in the device menu, see chapter 5.1.1 *Input INPUTS > AN. INP*, page 26

4-wire

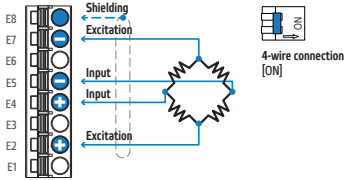

6-wire

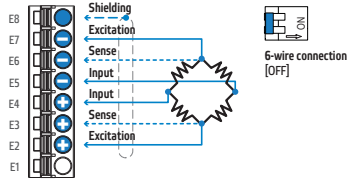

The DIP switch settings must correspond to the wiring variant of the connected sensor.

3.2 Connecting analog outputs

The output analog signal (active) is connected to the 3-pin connector in position **D**.

Output type and range options can be set in the device menu, [5.4.2 Outputs OUTPUT > ANALOG](#), [page 56](#).

The following figures provide detailed information on the wiring for each output type.

Output 1 - Current, active [mA]

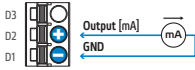

Output 1 - Voltage [V]

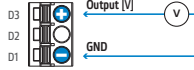

Range	
0...5 / 0...20 / 4...20 mA	D2
0...2 / 0...5 / 0...10 / ±10V	D3

Output 2 - Current, active [mA]

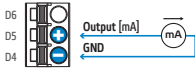

Output 2 - Voltage [V]

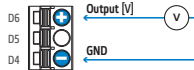

Range*	
0...5 / 0...20 / 4...20 mA	D5
0...2 / 0...5 / 0...10 / ±10V	D6

*applies when ordering a second analog output, which is installed in the RS232/485 data output position

3.3 Connecting data outputs

The output analog signal (active) is connected to the 3-pin connector in position **D**.

The communication format options for the currently used card can be set in the device menu; the example is for the RS 485 card, [5.5.2 Communication COMM > RS485](#), [page 68](#).

The following figures provide detailed information on the wiring for each type of output.

RS 232

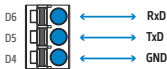

RS 485

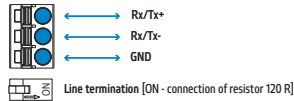

RS 232

Only one device can be connected to the computer, and the total cable length should not exceed 15 m. For connection we recommend using a twisted AWG28 / 0.08 mm² cable.



RS 485

Up to 32 devices can be connected to the computer, and the cable length should not exceed 500 m. For connection we recommend using twisted pair cable AWG28 / 0.08 mm². The last device on the line must have a terminating resistor of 120R (switch in the ON position).

3. Connecting the device

3.4 Connecting relay/OC outputs

The output signal is connected to the 3-pin connector in position **B**

The output types can be set in the device menu, **5.4.1 Outputs OUTPUT > RELAY**, [page 50](#).

The following figures provide detailed information on the wiring for each output type.

2 SPDT relay (Form C)

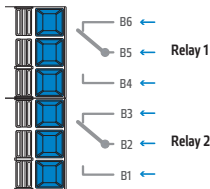

4 SPDT relay (Form C)

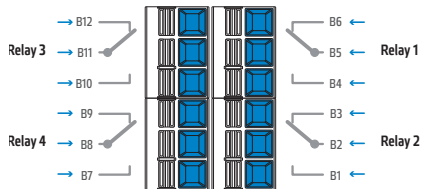

3 NO relay (Form A)

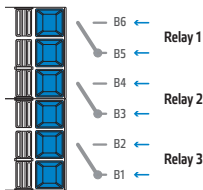

6 NO relay (Form A)

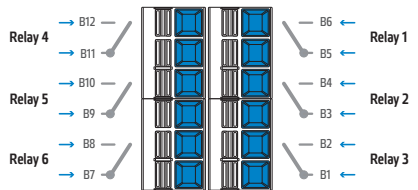

3 open collectors

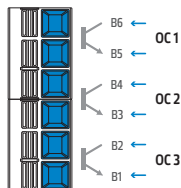

6 open collectors

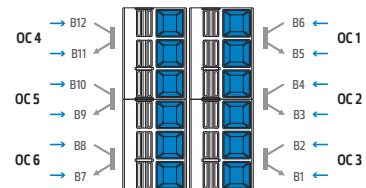

3.5 Connecting external control inputs

External control inputs are connected to the 6-pin connector in position **C**.

The input type (NPN/PNP) and function assignment can be set in the device menu, *5.1.3 Inputs INPUT > EXT.INP*, [page 36](#). The following figure provides detailed information about their connection.

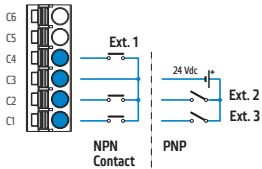

External inputs are isolated

3.6 READY output

The informative READY output is connected to the 6-pin connector in position **C**.

The output responds to error messages selected in the device menu, *5.6.9 Service SERVIC > ERR.SIG.*, [page 76](#).

The following figure provides detailed information about its connection.

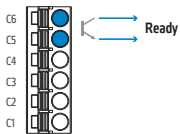

The output is active only if no error message is displayed on the device.
Open collector 30 VDC/100 mA

3.7 Connecting the device to the power supply

The device power supply is connected to the 3-pin connector in position **A**.

The following figure provides detailed information about its connection.

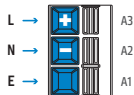

Color-coded terminals clearly identify the supply voltage range, minimizing the risk of incorrect connection and subsequent damage to the device due to incorrect supply voltage.

Blue	10...30 V
Red	80...250 V



Connect the device to the power supply only after connecting all other connectors. Failure to follow this procedure may result in electric shock or damage to the device.



The device is protected by a fuse inside the unit.
Power supply 10...30 V T 4000 mA
Power supply 80...250 V T 630 mA



SETUP GUIDE

FIRST START-UP OF THE DEVICE

4.1 Setup guide

The device setup wizard is a software tool designed to facilitate the initial configuration and setup of the device. It is an interactive program that guides users step by step through the setup process, detects the device configuration, and configures it according to preset parameters. The wizard simplifies and speeds up the basic setup process, allowing less experienced users to successfully set up the device with ease.

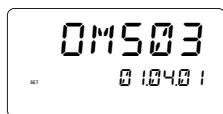

Introductory text

The primary display shows the type of device and the presently selected measurement range, while the secondary display shows the firmware version, which is always associated with the corresponding version of the user manual.

The next item is displayed automatically after approximately 2 seconds.



Starting the setup WIZARD

- ✓ Option - YES/NO
- ✓ Option - YES/NO
- ◀ Return to previous item
- ✓ Start/Pause Wizard



Menu for setting of INPUTS

- ✓ Confirm selection and continue setup using the Wizard
- ◀ Return to previous item



Menu for setting of ANALOG INPUTS

- ✓ Confirm selection and continue setup using the Wizard
- ◀ Return to previous item



Menu for selecting the measuring range

- ✓ Confirm selection and continue setup using the Wizard
- ◀ Return to previous item

4. First time turning on the device

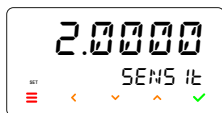
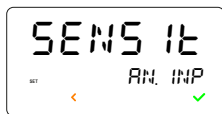
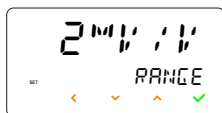

Measurement range selection

2mV/V 4mV/V 8mV/V 16mV/V

- ✓ Move to next item - down
- ⏏ Move to next item - up
- ⏏ Return to previous item
- ✓ Confirm selection and continue setup using the Wizard

Menu for setting sensor SENSITIVITY

- ✓ Confirm selection and continue setup using the Wizard
- ⏏ Return to previous item

Sensor SENSITIVITY settings

- ✓ Move to next number - down
- ⏏ Move to next number - up
- ⏏ Move to next decade - left
- ☰ Return to previous item
- ✓ Confirm selection and continue setup using the Wizard

Menu for setting CHANNELS

- ✓ Confirm selection and continue setup using the Wizard
- ⏏ Return to previous item

Menu for setting of CHANNEL A

- ✓ Confirm selection and continue setup using the Wizard
- ⏏ Return to previous item

Menu for setting the Maximum display value (Nominal load of the strain gauge)

- ✓ Confirm selection and continue setup using the Wizard
- ⏏ Return to previous item

Set the display value that corresponds to the maximum input value

- ✓ Move to next number - down
- ⏏ Move to next number - up
- ⏏ Move to next decade - left
- ☰ Return to previous item
- ✓ Confirm selection and continue setup using the Wizard

4. First time turning on the device



To enter a value with a decimal point, follow the instructions; otherwise, confirm selection and continue setup using the Wizard.

- Move beyond the last decade - All decimal points flash
- Move the decimal point - right
- Move the decimal point - left
- Confirm selection and continue setup using the Wizard

Menu for setting the Decimal point

- Confirm selection and continue setup using the Wizard
- Return to previous item

Decimal point settings

- Move Decimal point to the right
- Move Decimal point to the left
- Return to previous item
- Confirm selection and continue setup using the Wizard



The following settings depend on the device variant



Menu for setting OUTPUT

- Confirm selection and continue setup using the Wizard
- Return to previous item



Menu for setting RELAYS

- Confirm selection and continue setup using the Wizard
- Return to previous item



Menu for setting RELAY 1

- Confirm selection and continue setup using the Wizard
- Return to previous item

4. First time turning on the device



Menu for setting the source for the evaluation of RELAY 1

- ✓ Confirm selection and continue setup using the Wizard
- ◀ Return to previous item

Selecting the source for the evaluation of RELAY 1



Type	Description
OFF	Evaluation of Relay.1 is disabled
VALUE. A	Evaluation of Relay.1 is from Channel A value
MIN. A	Evaluation of Relay.1 is from the minimum value of Channel A
MAX. A	Evaluation of Relay.1 is from the maximum value of Channel A
ABS. A	Evaluation of Relay.1 is from the absolute value of Channel A
ERROR	Evaluation of Limit.1 with active error message

- ✓ Move to next number - down
- ▲ Move to next number - up
- ◀ Return to previous item
- ✓ Confirm selection and continue setup using the Wizard

Menu for selecting the mode of RELAY 1

- ✓ Confirm selection and continue setup using the Wizard
- ◀ Return to previous item

Selecting the mode of RELAY 1



Type	Description
RISE	Active above the set value
FALL	Active below the set value
WINDOW	Active within the set window/band
BATCH	Active at set multiples of the measured signal

- ✓ Move to next number - down
- ▲ Move to next number - up
- ◀ Return to previous item
- ✓ Confirm selection and continue setup using the Wizard

Menu for setting the setpoint of RELAY 1

- ✓ Confirm selection and continue setup using the Wizard
- ◀ Return to previous item

4. First time turning on the device



Setting the setpoint of RELAY 1

-9999...0...99999

- ▼ Move to next number - down
- ▲ Move to next number - up
- ◀ Move to next decade - left
- ≡ Return to previous item
- ✓ Confirm selection and continue setup using the Wizard

Menu for selecting the Hysteresis for RELAY 1

- ✓ Confirm selection and continue setup using the Wizard
- ◀ Return to previous item

Setting Hysteresis for RELAY 1

0...99999

- ▼ Move to next number - down
- ▲ Move to next number - up
- ◀ Move to next decade - left
- ≡ Return to previous item
- ✓ Confirm selection and continue setup using the Wizard

Menu for selecting Delay for RELAY 1

- ✓ Confirm selection and continue setup using the Wizard
- ◀ Return to previous item

Setting the delay for RELAY 1 [in seconds]

0...99999,9

- ▼ Move to next number - down
- ▲ Move to next number - up
- ◀ Move to next decade - left
- ≡ Return to previous item
- ✓ Confirm selection and continue setup using the Wizard

Menu for Analog Output

- ✓ Confirm selection and continue setup using the Wizard
- ◀ Return to previous item

4. First time turning on the device

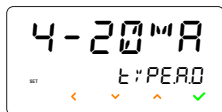

Menu for selecting Analog Output type

- ✓ Confirm selection and continue setup using the Wizard
- ◀ Return to previous item

Analog output type selection

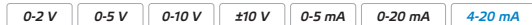

- ✓ Move to next item - down
- ▶ Move to next item - up
- ◀ Return to previous item
- ✓ Confirm selection and continue setup using the Wizard

Menu for setting the Minimum of range of the Analog output

- ✓ Confirm selection and continue setup using the Wizard
- ◀ Return to previous item

Setting the value for the Minimum of range of the Analog Output

-9999...4...99999

- ✓ Move to next number - down
- ▶ Move to next number - up
- ◀ Move to next decade - left
- ≡ Return to previous item
- ✓ Confirm selection and continue setup using the Wizard

Menu for setting the Maximum of range of the Analog output

- ✓ Confirm selection and continue setup using the Wizard
- ◀ Return to previous item

Setting the value for the Maximum of range of the analog output

-9999...20...99999

- ✓ Move to next number - down
- ▶ Move to next number - up
- ◀ Move to next decade - left
- ≡ Return to previous item
- ✓ Confirm selection and continue setup using the Wizard

4. First time turning on the device



Service functions menu

- ✓ Confirm selection and continue setup using the Wizard
- ◀ Return to previous item



Menu for setting the access password

- ✓ Confirm selection and continue setup using the Wizard
- ◀ Return to previous item

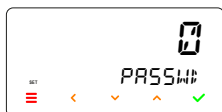

Access password settings

0...9999

The set password applies to both accessing the device menu via the front panel keys as well as connecting the device to the OM Link SW app via the USB-C connector. When the password is set to **0000** (default), access to the menu is unrestricted and there is no prompt to enter any password.

- ✓ Move to next number - down
- ✓ Move to next number - up
- ✓ Move to next decade - left
- ✓ Confirm selection and exit wizard (with saving)



The Wizard is only active during the first startup of the device. If needed, repeated startup of Wizard can be enabled in the Service/Wizard menu, [page 87](#)

4.2 Input Setting and Calibration for load cell (strain gauge) sensors

The device allows direct connection of load cell sensors for force, pressure, or weight with 4- or 6-wire connectivity and a defined sensitivity in mV/V. For proper operation, it is necessary to set the input parameters and then calibrate the measuring range.

Theoretical calibration by entering Sensor Parameters



Enter the data shown on the sensor (or its datasheet) into the device:

- **Sensitivity** [SENSIT]: e.g., 2,1245 mV/V
- **Nominal range** [DIS.MAX]: e.g., 100 kg

This allows the device to determine the relationship between input voltage and the measured quantity. For example, with a sensitivity of 2 mV/V and 10 VDC excitation, the full-scale signal corresponds to 20 mV.

Advantages

- Quick and convenient setting without the need to physically move any loads or weights

Disadvantages

- Accuracy depends on the data taken from the sensor label / datasheet
- Does not include the effects of the overall mechanical structure

Live calibration using Reference Load



This method involves physical calibration with a known referential weight and ensures the highest accuracy possible. Perform a two-point calibration – at the MIN and MAX points:

- **Min** [t-IN.LO]: empty scale (zero load)
- **Max** [t-IN.HI]: apply a standardized load representing a known weight
- **Nominal range** [DIS.MAX]: e.g., 100 kg

To achieve optimal accuracy, we recommend that the calibration weight correspond to at least 2/3 of the measuring range

Advantages

- Highest accuracy of the 3 methods, includes the properties of the mechanical structure and the sensor
- Verification of the actual functionality of the entire system (sensor + device).

Disadvantages

- Requires physical load and mechanical access to the sensor.
- Not suitable for laboratory simulations or permanently built-in sensors

Calibration According to Electrical Parameters



Alternatively, calibration can be performed without a physical load by entering known electrical parameters of the measuring range:

- **Output at zero load** [MAN. LO]: e.g., +0,002 mV/V
- **Output at maximum load** [MAN. HI]: e.g., +20,458 mV/V
- **Nominal range** [DIS.MAX]: e.g., 100 kg

Based on this data, the device calculates the conversion factor between the input signal and the measured quantity.

Advantages

- No physical handling of the load is necessary

Disadvantages

- For some users, determining the exact electrical parameters of the system can be challenging

5. Device settings

SETTINGS

Complete device menu

Access is password protected

Tree structure menu

■ Accessing the device menu



- by pressing this key
- access is password protected. It is set to „0000“ by default (with this setting, the device will not prompt you to enter the password)



To ensure safe and reliable operation of the device, we recommend setting an access password immediately upon its first start-up.
The password can be set in the *SERVIC./PASSWD. menu*



In case of inactivity exceeding 60 seconds while in the menu, the programming mode is automatically terminated, and the device returns to the measuring mode by itself.



When the device is powered via the USB-C connector (no external mains power) while connected to PC, only configuration of the device is possible when using the OM Link software.

In this mode, peripheral functions such as analog output, data output, relays, or auxiliary power may not be active.
Full functionality of all peripherals is only available when the device is either externally powered or when using a sufficiently powerful USB-C port on the PC.

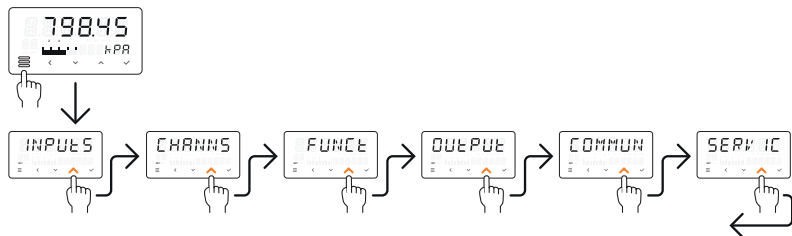

■ The menu is divided into six basic sections

INPUTS Input parameters settings

Analog input	Input type and range, rate of measurement, teach-in
Ext. input	Function of external (logic) inputs
Keys	Control button functions

CHANN S Measurement channels settings

For an easy orientation, the device menu uses CHAN. A - C which are then assigned individual parameters and functions.

Zeroing	Zeroing (clearing) of Tare, zeroing of Min/Max values, ...
Source	Input value (set in the menu item INPUT), Electrical value of the input
Parameters	Settings of display, offset, decimal point, units, description, display colors
Recording	Settings for recording measured values
Filter	Settings of digital filters
Math. fn	Settings of math functions

FUNCT Functions setting

Timer	Setting time windows in which device functions and peripherals are active
-------	---

OUTPUT Setting of output

Relay	Selecting the type, mode, and setting values
Analog	Selecting the type and range
Display	Brightness setting, Selection of values displayed for individual displays, Bargraph setting
Memory	Setting parameters for the recording of measured values to the device memory

COMMUN Setting of communication and recording

RS 485	Setting of data communication parameters, RS 232, RS 485, Modbus, Ethernet, etc.
Bluetooth	Setting of Bluetooth communication parameters

SERVIC Service settings

Password	Set a password for accessing the menu and/or connecting the device to a PC
Delayed start	Sets the delay time [s] after power-up before measurement starts
Settings	Download or upload device settings, or perform a factory reset
Calibration	Return to factory calibrations (after user calibration using a script in the OM Link app)
Date, time	Set the date and time
Language	Select the menu language version
Errors	Select errors that will be signaled by LEDs on the front panel and via the analog output
Wizard	Repeated launch of the device setup Wizard
Simulation	Simulation of the input signal
Information	Operating information about the device

5. Device settings

5.1 Setting - INPUTS

5.1.1 Analog input settings

5.1.1a Sampling rate

☰ INPUTS ✓ AN. INP ✓ RATE

RATE
AN. INP



10
RATE

Parameter	Setting	Description
Sample rate	RATE	Selection of sampling rate for analog input The sampling rate setting is used to adjust the response and accuracy of the device according to application requirements. It optimizes output stability and minimizes noise.
10	10	10 measurements/second DEF
Value selection 5/10/20/50/100/400/1200		



5.1.1b Measuring range

☰ INPUTS ✓ AN. INP ✓ RATE ▲ RANGE

RANGE
AN. INP



2mV/V
RANGE

Parameter	Setting	Description
Measuring range	RANGE	Selection of the measuring range It determines the maximum input sensitivity of the converter in mV/V units. Setting the correct range ensures optimal use of resolution and measurement accuracy.
2mV/V	2mV/V	0...2 mV/V DEF
4mV/V	4mV/V	0...4 mV/V
8mV/V	8mV/V	0...8 mV/V
16mV/V	16mV/V	0...16 mV/V



5.1.1c Setting the sensitivity of the load cell sensor

☰ INPUTS ✓ AN. INP ✓ RATE ▲▲ SENS IL

SENS IL
AN. INP



2.0000
SENS IL

Parametr	Nastavení	Popis
Sensitivity (mV/V)	SENS IL	Setting the sensitivity of the load cell sensor Allows you to enter the nominal sensitivity of the sensor in mV/V, according to which the device converts the measured signal to the corresponding physical quantity (e.g., weight or force). Correct sensitivity setting is absolutely essential for accurate calibration.
Setting range: 1...17.0000		



5.1.1d Selection of special functions for the WEIGHT mode

☰ INPUTS ✓ RN, INP ✓ PRLE ▲▲▲ WE IGHE

WE IGHE
RN, INP



W. FUNC
WE IGHE

Parametr	Nastavení	Popis
Function settings	WE IGHE	Selection of special functions for the WEIGHT mode It determines the measuring mode of the device
W. FUNC	W. FUNC	Activation of weighing functions
TRACK.0	ERRCH:0	Automatic tracking of the zero point*
AUT.TAR	AUT.TAR	Automatic tare function*
DIVISI	1 1/15 1	Size of a scale division *

☰ → ✓ →

**This option is available only when Weighing functions are enabled (W. FUNC>YES)*

5.1.1e Activation of weighing functions

☰ INPUTS ✓ RN, INP ✓ PRLE ▲▲▲ WE IGHE ✓ W. FUNC

W. FUNC
WE IGHE



YES
W. FUNC

Parametr	Nastavení	Popis
Měřicí mód	W. FUNC	Activation of weighing functions This menu item activates weighing functions in the device
NO	NO	Weighing functions are inactive Standard measurement mode, intended for universal applications
YES	YES	Weighing functions are active DEF A special mode optimized for weighing, which offers extended features. - setting the scale division size, tracking the zero point, and automatic taring.

☰ → ✓ →



The following menu items are available only in WEIGHT mode

TRACK.0	Automatic zero tracking
AUT.tAR	Automatic taring
DIVISI	Size of a scale division



For optimal accuracy, we recommend that the calibration weight correspond to at least 2/3 of the measurement range.



The device allows for 3 types of calibration, and their description and advantages can be found on [page 23](#)

5. Device settings

5.1.1e.1 Automatic zero tracking selection*

≡ INPUTS ✓ AN. INP ✓ PRLEE ⬆️ ⬆️ ⬆️ WE IGHLE ✓ W. FUNC ⬆️ ERACK:0

ERACK:0
WE IGHLE



YES
ERACK:0

Parametr	Nastavení	Popis
Sledování nuly	ERACK:0	<p>Automatic tracking of the zero point*</p> <p>The automatic zero tracking function operates within a narrow range around the zero point and continuously compensates for small deviations. Its goal is to keep the display steady at "0" even if minute signal fluctuations occur. The function does not affect the actual load – when an object is placed on the scale, the change is immediately reflected because it exceeds the set zero tracking limit. Automatic zero tracking thus suppresses noise and minor signal fluctuations and makes operation easier by eliminating constant deviations around the zero point.</p>
YES	YES	<p>Function is active DEF</p> <p>If this function is active, the device automatically maintains the display at "0" during small signal changes around the zero point. Zero tracking occurs if the measured value is less than 2% of the range and is evaluated once per second.</p> <ul style="list-style-type: none"> • If the zero deviation is less than 1/2 of a scale division, zero shifts by the full measured value every second. • If the deviation is greater than 1/2 of a scale division, zero shifts by half a scale division per second. <p>The display shows the automatic balancing progress symbol:</p> <ul style="list-style-type: none"> ➔ 0 Automatic balancing upward 0 ⬅️ Automatic balancing downward ➔ 0 ⬅️ Automatic balancing stabilized (zero stable)
NO	NO	<p>Function is inactive</p> <p>The zero point is not corrected – all deviations from zero are displayed on the screen and must be eliminated by manual zeroing (taring).</p>



*This option is available only when Weighing functions are enabled (W. FUNC>YES)

5.1.1e.2 Automatic tare selection*

≡ INPUTS ✓ AN. INP ✓ PRLEE ⬆️ ⬆️ ⬆️ WE IGHLE ✓ W. FUNC ⬆️ RUL:EAR

RUL:EAR
WE IGHLE



YES
RUL:EAR

Parametr	Nastavení	Popis
Automatické tárování	RUL:EAR	<p>Automatic tare selection*</p> <p>Automatic taring is normally performed only for stable negative values. The purpose of the function is to compensate for the residual negative weight that occurs after removing a load from the weighing platform (e.g., due to inertia, load cell deformation, etc.). If the device measures a stable negative value for more than 5 seconds, i.e., within the range of one scale division, the display value will automatically be zeroed.</p>
YES	YES	<p>The function is active DEF</p> <p>When turned on, the weight sensor status is automatically set to zero. Small initial loads are ignored, and "0" is displayed. This way, the operator does not have to perform manual taring at each startup.</p>
NO	NO	<p>The function is turned off</p> <p>After power on, the device does not automatically zero the display. Any load on the sensor will be shown on the display, and it is necessary to zero it manually using the tare function.</p>



*This option is available only when Weighing functions are enabled (W. FUNC>YES)

5.1.1e.3 Setting the scale division size*

☰ INPUTS ✓ RN, INP ✓ RRE ✓ WE IGH ✓ W. FUNC ✓ 1/ 15 1

1/ 15 1
WE IGH



0.001
1/ 15 1

Parametr	Nastavení	Popis
Velikosti dílku	1/ 15 1	Setting the scale division size* Determines the resolution of the weighing results display. The scale division is the smallest unit of value change (e.g., 0.001 = three decimal places). A smaller division increases susceptibility to disturbances, a larger scale division size ensures a more stable value on the display but with lower accuracy.
	0.001	0.001 DEF
		Fine resolution: 0.001 / 0.002 / 0.005 Medium resolution: 0.01 / 0.02 / 0.05 Coarser resolution: 0.1 / 0.2 / 0.5 Coarse steps: 1 / 2 / 5 / 10 / 20 / 50 / 100



*This option is available only when Weighing functions are enabled (W. FUNC>YES)

5.1.1f Calibration with reference load - MINIMUM

☰ INPUTS ✓ RN, INP ✓ RRE 4x ✓ 1 - INLO

1 - INLO
RN, INP



YES?
1 - INLO

Parametr	Nastavení	Popis
Calibration with reference load	1 - INLO	Calibration with reference load - MINIMUM (ZERO) This method represents live physical calibration using a known weight and ensures the highest measurement accuracy.
ZERO	YES?	YES? The Teach-in function measures the signal that corresponds to an empty scale The device measures the current value of the input signal and assigns it to the display for the minimum value of the input range <i>DIS.MIN</i>
		<ul style="list-style-type: none"> ● Make sure the scale is empty ● When prompted by the device, confirm the selection with YES



5.1.1g Calibration with reference load - MAXIMUM

☰ INPUTS ✓ RN, INP ✓ RRE 5x ✓ 1 - INH 1

1 - INH 1
RN, INP



YES?
1 - INH 1

Parametr	Nastavení	Popis
Calibration with reference load	1 - INH 1	Calibration with reference load - MAXIMUM This method represents live physical calibration using a known weight and ensures the highest measurement accuracy.
MAXIMUM	YES?	YES? The Teach-in function measures the signal for a loaded scale In Teach-in mode, the device measures the current input signal under load and assigns it to the display value corresponding to the maximum of the range <i>DIS.MAX</i>
		<ul style="list-style-type: none"> ● Place a reference weight corresponding to the known mass on the scale. ● When prompted by the device, confirm the selection with YES



5. Device settings

5.1.1h EXPERT input settings

☰ INPUTS ✓ AN. INP ✓ RRL E 6x ▲ E:PERL

E:PERL
AN. INP



MAN. LO
E:PERL

Parametr	Nastavení	Popis
EXPERT setting	E:PERL	EXPERT input settings EXPERT mode enables advanced input configuration and precise display scaling. Setting method is available: MANUAL (manual entry).
MAN. LO	MAN. LO	Manual entry of the signal value for the minimum The manually entered input signal value is assigned to the display as corresponding to the minimum value DIS.MIN ● Enter a known value corresponding to the minimum input signal
MAX.HI	MAN.HI	Manual entry of signal value for the maximum The manually entered input signal value is assigned to the display as corresponding to the maximum value DIS.MAX ● Enter a known value corresponding to the maximum input signal
RSt.RNG	RSt.RNG	Reset of measuring range This function will cancel your user input calibration and restore the input default factory settings. After performing this, it is necessary to perform the set up and re-calibrate the input. ● When prompted by the device, confirm your selection with YES



The device allows for 3 types of calibration, and their description and advantages can be found on [page 23](#)

5.1.1i Setting the filter for the suppression of mains hum*

☰ INPUTS ✓ AN. INP ✓ RRL E 67x ▲ HUM.F IL

HUM.F IL
AN. INP



YES?
HUM.F IL

Parameter	Setting	Description
Hum suppression	HUM.F IL	Filter setting for the suppression of mains hum* The filter is used to suppress interference caused by the mains frequency of 50 and 60 Hz. Using IIR processing (Infinite Impulse Response), the measurement signal is integrated over the entire period of the interference, effectively eliminating the influence of the mains hum coming from the power supply or electromagnetic fields from nearby devices. This method significantly improves measurement stability and accuracy, especially with low signals or in environments with strong electromagnetic interference.
YES?	YES?	Filter activation After activating the filter, the set measurement rate remains unchanged. The device provides more stable and accurate results in environments with strong network interference



*available only for measurement speeds > 100 measurements/sec.

5.1.2a Selecting the function of external input 1

 INPUTS  AM. INP   EXT. INP  EXT. 1  ACT. 1 ON





Parameter	Setting	Description
Function for EXT. 1	ACT. 1 ON	Selects the function of external (logic) input Isolated external inputs enable remote control of selected device functions.
OFF	OFF	External input is disabled
tARE.A	TARE.A	Tare activation [TARE.B - C] DEF Activating the input turns on the Tare function
CL.tAR.A	CL.TARE.A	Clears tare (Tare reset) [CL.TAR.B - C] Activating the input resets the current value of tare.
tR.+CL.A	T.R.+CL.A	Activates Tare (<1 s) + Resets Tare (>1 s) [T.R.+CL.B - C] A combined function that allows a single input to be used for two functions, Tare activation and tare reset. The input is controlled by the length of the control pulse.
CUMULA	CUMUL.A	Controls cumulative measurement [CUMUL.B - C] Cumulative incremental measurement
CL.M.M.A	CL.M.M.A	Clears Min/Max values [CL.M.M.B - C] Activating the input resets the Min/Max values
CL.PK.A	CL.PK.A	Resets the peak value [CL.PK.B - C] Activating the input resets the peak value PEAK A
SAMPLE	SAMPLE	Takes a single measurement Activating the input initiates a single measurement of the input signal. The measured value remains displayed until the next activation..
HOLD	HOLD	Stops the measurement process Activating the input stops the measurement. The display and other functions and outputs are blocked.
HLD.MIN	HLD:MIN	Holds the Minimum value After activating the input, the display shows the minimum value of the input signal recorded since the last activation of the external input.
HLD.MAX	HLD:MAX	Holds the Maximum value After the input is activated, the display shows the maximum value of the input signal recorded since the last activation of the ext. input.
HLD.M-M	HLD:M-M	Holds the MAX-MIN value After activating the input, the display shows the difference between the maximum and minimum values of the input signal recorded since the last activation of the external input.
HLD.AVG	HLD:AVG	Holds the Average value After activating the input, the display shows the average value of the input signal calculated since the last activation of the external input..
LATCH	LATCH	Releases Safety relay/Open Collector Activation of the input deactivates the safety relay/OC, which is set to LATCH mode (blocked release).
RECORD	RECORD	Records measured data Activation of the input starts recording measured values into memory
KEY.LCK	KEY:LCK	Locks (disables) the keys on the device Activation of the input Activating the input locks the keys on the front panel, turns off their.



All options for Channels B and C are displayed only if they are active

5. Device settings

5.1.2b Selecting temporary display projection controlled by external input 1

☰ INPUTS ✓ AN. INP ⬆ ⬆ E#E. INP ✓ E#E. 1 ✓ ACT. 1DN ⬆ VIEW

VIEW
FUNCTION



TARE.A
VIEW

Parameter	Setting	Description
Temporary value for EXT.1	VIEW	Temporary display option for External input Isolated external inputs can control temporary projection of selected measured values.
OFF	OFF	External input is disabled
VALUE.A	VALUE.A	Projection of Channel A value [VALUE.B - C] Activating the external input displays the current value (Channel A)
MIN. A	MIN.A	Projection of the minimum value of Channel A [MIN.B - C] Activating the external input displays the minimum value (Channel A)
MAX. A	MAX.A	Projection of the maximum value of Channel A [MAX.B - C] Activating the external input displays the maximum value (Channel A)
PEAK A	PEAK.A	Projection of the peak value of Channel A [PEAK.B - C] Activating the external input displays the peak value (Channel A)
TARE A	TARE.A	Projection of Tare [TARE.B - C] DEF Activating the external input displays the Tare value
GROSS.A	GROSS.A	Projection of Gross weight [GROSS.B - C] Activating the external input displays the value of VALUE.A + TARE A



All options for Channels B and C are displayed only if they are active



Each input can be assigned only one function: either ACTION or VIEW.

When one of the functions is selected, the other is automatically deactivated.

5.1.2c Selecting the function of external inputs 2 and 3

☰ INPUTS ✓ AN. INP ⬆ ⬆ E#E. INP ✓ E#E. 1 ✓ E#E. 2 ⬆ ACT. 1DN



The setting of functions for EXT. 2 and EXT. 3 are identical to those for external input 1

5.1.2d Selecting the type of connection for external inputs 2 and 3

☰ INPUTS ✓ AN, INP ⤴ ⤴ E:EXT, INP ✓ E:EXT, I ⤴ ⤴ E:PE



Parameter	Setting	Description
External input function type	E:PE	Selecting the type of External input Activation of external inputs 2 and 3 can be set according to the application requirements. The correct selection of the switching type is crucial to ensure the compatibility of the device with external devices, sensors, and switching mechanisms in the given system.
NPN	NPN	NPN switching/contact In this mode, the external input is activated by connecting to zero potential (GND). DEF Activation occurs when the input terminal is connected to ground, which is typical for: <ul style="list-style-type: none"> ● NPN transistors ● Mechanical contacts such as buttons or switches
PNP	PNP	PNP switching In this mode, the external input is activated by connecting it to positive potential (+V). Activation occurs when the input terminal is connected to the positive supply voltage, which is common for: <ul style="list-style-type: none"> ● PNP transistors ● Sensors or switching mechanisms that require power from the positive pole



Control by a voltage-free (dry) contact

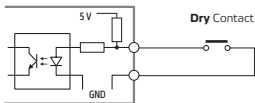

Control by signal with positive logic (P)

Power supply range: 10...30 VDC

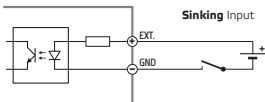

Control by signal with negative logic (M)

Power supply range: 10...30 VDC

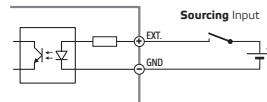

Control by PNP sensor

Power supply range: 10...30 VDC

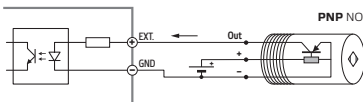

Control by NPN sensor

Power supply range: 10...30 VDC

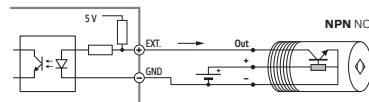

5. Device settings

Function HLD.MIN

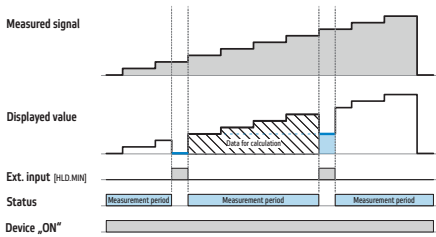

Function HLD.MAX

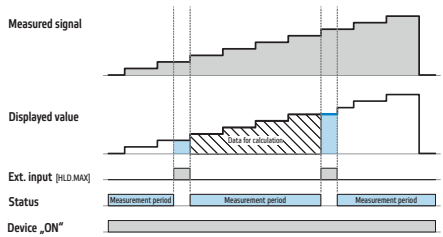

Function TARE with Reset

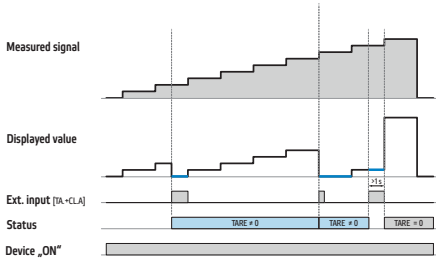

Function HLD.AVG

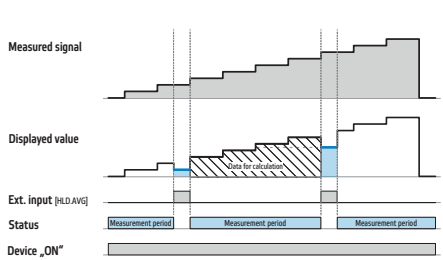

Function HOLD

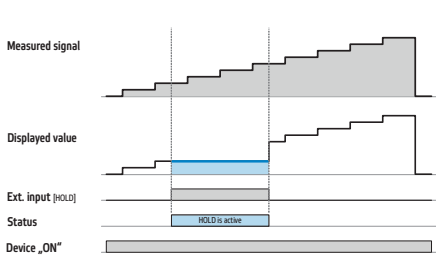

Function SAMPLE

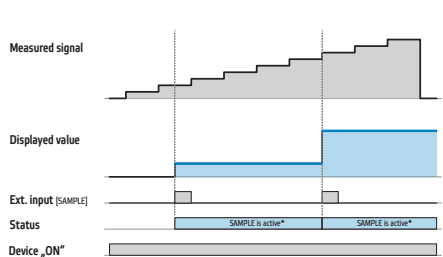

*one-off measurement of the input value is triggered by the rising edge

Cumulative measurement

Example

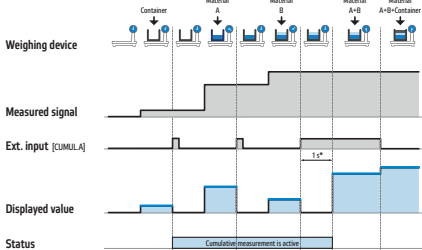

*A signal longer than 1s ends the incremental measurement cycle and the total sum is transferred via the output signal



Application notes are available on our website

www.orbitmerret.eu/en/om-503t#download

under the "Download Support" tab. They provide a detailed description of the device's properties, functions, and usage.

5.1.3 Selection of additional functions assigned to buttons

5.1.3a Additional functions of button LEFT

☰ INPUTS ✓ AN, INP ▲ ▲ ▲ BUTTON ✓ LEFT ✓ ACT IDN

ACT IDN
LEFT



TARE A
ACT IDN

Parameter	Setting	Description
Button LEFT function selection	ACT IDN	Button function selection The LEFT button can be assigned one of the device's executive functions. Selecting the appropriate function increases the efficiency of working with the device and facilitates its operation in a specific application.
OFF	OFF	The additional function of the button is disabled
TARE A	TARE A	Tare activation [TARE B - C] DEF Pressing the button turns on the Tare function
CL.TAR.A	CL.TAR.A	Tare reset [CL.TAR.B - C] Pressing the button resets (clears) the current tare value.
CL.M.M.A	CL.M.M.A	Clearing Min/Max values [CL.M.M.B - C] Pressing the button resets the Min/Max value.
CL.PK.A	CL.PK.A	Clearing the peak value [CL.PK.B - C] Pressing the button resets the peak value.
SAMPLE	SAMPLE	One-time measurement Pressing the button starts a single measurement of the input signal. The measured value remains displayed until the button is pressed again..
OPN.REL	OPN.REL	Opening the safety relay/OC Pressing the button deactivates the safety relay/OC, which is set to LATCH mode (blocked dropout).
SAV.VAL	SAV.VAL	Recording of measured data - one-time storage Pressing the button saves the measured values to memory.
SW.DISP	SW.DISP	Switching projection on the primary display* Pressing the button switches the projection of selected channels/values.



*option available only if OUTPUTS/DISP/PRIMAR/SW.DISP function is enabled
All options for Channels B and C are displayed only if they are active



Each input can be assigned only one function: either ACTION or VIEW.

When one of the functions is selected, the other is automatically deactivated.

5. Device settings

5.1.3b Temporary projection options for the button LEFT

≡ INPUTS ✓ AN, INP ▲ ▲ ▲ ▲ BUtTON ✓ LEFT ✓ RCt IDN ▲ V IEW

V IEW
LEFT



V AL. A
SHOW

Parameter	Setting	Description
Assigning temporary projection to button LEFT	V IEW	Selecting temporary projection The button can be set to project a selected menu item or value when pressed. Choosing the right function increases the efficiency of working with the device and facilitates its operation in a specific application.
OFF	OFF	The additional function of the button is disabled
VALUE. A	V AL. A	Show the value of Channel A [VALUE. B - C] Press the button LEFT to display the current value (Channel A)
MIN. A	M IN. A	Show the minimum value of Channel A [MIN. B - C] Press the button LEFT to display the minimum value (Channel A)
MAX. A	M AX. A	Show the maximum value of Channel A [MAX. B - C] Press the button LEFT to display the maximum value (Channel A)
PEAK. A	P EAK. A	Show the peak value of Channel A [PEAK. B - C] Press the button LEFT to display the peak value (Channel A)
TARE. A	T ARE. A	Show the tare [TARE. B - C] DEF Press the button LEFT to display the Tare value
GROSS.A	G ROSS.A	Show GROSS value Press the button LEFT to display value VALUE. A + TARE. A



All options for Channels B and C are displayed only if they are active

5.1.3c Selecting quick access to a selected item for the button LEFT

≡ INPUTS ✓ AN, INP ▲ ▲ ▲ ▲ BUtTON ✓ LEFT ✓ RCt IDN ▲ ▲ MENU

MENU
LEFT



SEtPO. 1
MENU

Parameter	Setting	Description
Direct access for the button LEFT	MENU	Direct access to the menu for the selected item The button can be set to display the selected menu item or value when pressed. The appropriate function selection increases the efficiency of working with the device and facilitates its control in a specific application.
OFF	OFF	Direct access to a menu item is disabled
SETPO.1	SEtPO. 1	Direct access to item SETPO.1 [SEtPOI. 1-6] Press the button LEFT to displays the SETPOI item for RELAY.1 Depending on the device HW configuration, direct access can be set for Relays 1-6



5.1.3e Additional functions of button DOWN

☰ INPUTS ✓ AN. INP ^ ^ ^ BUTTTON ✓ LEFT ^ ↓ DOWN ✓ FUNCT



The function settings for the DOWN, UP and ENTER buttons are identical to those for the button LEFT.

5. Device settings

5.2 Setting of CHANNELS

Channels increase the capabilities of the measuring device when recording, checking, and evaluating measured processes and quantities. Channels enable simpler device settings and separate data processing, which facilitates their evaluation. This makes it easy to compare signals from various sensors or monitor system behavior at multiple locations simultaneously.

5.2.1 Resetting internal values

≡ INPUTS ▲ CHANNELS ✓ CLEAR

CLEAR
CHANNELS



tARE A
CLEAR

Parameter	Setting	Description
Clear	CLEAR	Clear internal device values This function allows you to reset various internal values of the device. Availability of individual items depends on the current configuration of the device.
tARE A	tARE A	Clear Tare [tARE. B - C] Press the button and confirm the YES? prompt to reset the selected value.
tAR.ALL	tAR.ALL	Clear Tare - All channels Press the button and confirm the YES? prompt to reset the tares of all channels.
MI.MA. A	MI.MA. A	Clear min/max values [MI.MA. B - C, AL] Press the button and confirm the YES? prompt to reset the stored min/max values reached during the measurement.
PEAK A	PEAK A	Clear peak values [PEAK. B - C, AL] Press the button and confirm the YES? prompt to reset the stored peak value.



All options for Channels B and C are displayed only if they are active

5.2.2 Setting of Channel A

5.2.2a Selecting the source of input value - CHANNEL A

≡ INPUTS ▲ CHANNELS ✓ CLEAR ▲ CHANNEL A ✓ SOURCE

SOURCE
CHANNEL A



ACT.VAL
SOURCE

Parameter	Setting	Description
Source selection	SOURCE	Selecting the source of input value Used for the selection of the signal source that will be further processed in Channel A.
ACT.VAL	ACT.VAL	Actual analog input value DEF This is a signal that has been processed according to the settings in the INPUT menu item.



5.2.2b Setting of the minimum display value - CHANNEL A

☰ INPUTS ▲ CHANNELS ✓ CLEAR ▲ CHANNEL A ✓ SOURCE ▲▲▶ 15.M IN

▶ 15.M IN
CHANNEL A



4
▶ 15.M IN

Parameter	Setting	Description
Displayed Minimum value	▶ 15.M IN	<p>Display settings for the minimum value of the input signal</p> <p>The range of the electrical signal (mV) can be converted to any range of displayed values (e.g., kg, N, kN, etc.).</p> <p>This item sets the minimum value of the converted range, which corresponds to the minimum value of the electrical input signal.</p> <p><i>Example</i></p> <p>It is required to display the value in kilograms. Set the minimum value of the converted range to 0 and the maximum value to 100. Then 0 mV will be displayed as 0 and 20 mV as 100 kg.</p> <p><i>For a sensor sensitivity of 2 mV/V and a supply voltage of 10 V.</i></p> <p>Setting range: -99999...999999</p>

5.2.2c Setting of the maximum display value - CHANNEL A

☰ INPUTS ▲ CHANNELS ✓ CLEAR ▲ CHANNEL A ✓ SOURCE ▲▲▶ 15.MA #

▶ 15.MA #
CHANNEL A



20
▶ 15.MA #

Parameter	Setting	Description
Displayed Maximum value	▶ 15.MA #	<p>Display settings for the maximum value of the input signal</p> <p>The range of the electrical signal (mV) can be converted to any range of displayed values (e.g., kg, N, kN, etc.).</p> <p>This item sets the maximum value of the converted range, which corresponds to the maximum value of the electrical input signal.</p> <p><i>Example</i></p> <p>It is required to display the value in kilograms. Set the minimum value of the converted range to 0 and the maximum value to 100. Then 0 mV will be displayed as 0 and 20 mV as 100 kg.</p> <p><i>For a sensor sensitivity of 2 mV/V and a supply voltage of 10 V.</i></p> <p>Setting range: -99999...999999</p>

5.2.2d Offset of the Measuring range start point - CHANNEL A

☰ INPUTS ▲ CHANNELS ✓ CLEAR ▲ CHANNEL A ✓ SOURCE ▲▲▲ OFFSEŁ

OFFSEŁ
CHANNEL A



0
OFFSEŁ

Parameter	Setting	Description
Offset	OFFSEŁ	<p>Setting/offsetting the zero point of measurement from the actual zero</p> <p>Offset is used to adjust the measuring instrument so that it accurately displays values within the required range. This compensates for any deviations caused by input signal or sensor errors.</p> <p>The offset value is permanently stored in the device memory and it remains there even after the device is turned off.</p> <p>Setting range: -99999...0...999999</p>

5. Device settings

5.2.2e Offsetting the start of range using the Teach-in function - CHANNEL A

≡ INPUTS ▲ CHANNELS ✓ CLEAR ▲ CHANNEL A ✓ SOURCE 4x ▲ ⌂ - IN.OF

⌂ - IN.OF
CHANNEL A



⌂ ESP.
OFFSET

Parameter	Setting	Description
Offset using Teach-in function	⌂ - IN.OF	<p>Offsetting the start point of the measuring range using the Teach-in function</p> <p>This function is used in cases where the exact value by which the start point of the measuring range needs to be offset is not known in advance. Unlike the manual Offset function, the Teach-in Offset function allows the device to measure the offset value automatically.</p> <p>The device measures the actual value of the input signal, stores it in memory, and then automatically subtracts this value from all future measurements, ensuring that zero is displayed on the display.</p>
YES?	⌂ ESP.	<p>Setup procedure</p> <ul style="list-style-type: none"> ● Connect to the device input terminals the signal source or a sensor for which you want to set the zero value on the display. ● When prompted by the device, confirm your selection by YES <p>Zeroing is possible in the OFFSET item by setting it to 000000</p>



5.2.2f Selecting the decimal point position - CHANNEL A

≡ INPUTS ▲ CHANNELS ✓ CLEAR ▲ CHANNEL A ✓ SOURCE 5x ▲ ⌂ EC.PE

⌂ EC.PE
CHANNEL A



00000.0
EC.PE

Parameter	Setting	Description
Decimal point	⌂ EC.PE	<p>Selecting the decimal point position</p> <p>It determines the format for displaying numerical values on the display. The setting allows you to adjust the accuracy and readability of the displayed value according to the requirements of the application.</p>
	000000	No decimal place
	00000.0	One decimal place DEF
	0000.00	Two decimal places
	000.000	Three decimal places
	00.0000	Four decimal places*
	0.00000	Five decimal places*
FLOAt	FLOAt	<p>Floating decimal point</p> <p>The device automatically adjusts the position of the decimal point according to the size of the value so that it is displayed with maximum accuracy and readability.</p>
EXPON	EXPON	<p>Exponential display format</p> <p>The value is displayed in the exponential (scientific) form, e.g. 1.23E+03 instead of .1230. This format is suitable for extremely small or large values that would otherwise not fit into the fixed display format or would be difficult to read.</p>



* Available only when unit projection is turned off

5.2.2g Display of measurement units - CHANNEL A

☰ INPUTS ▲ CHANNELS ✓ CLEAR ▲ CHANNEL A ✓ SOURCE 6x ▲ UN IT

UN IT
CHANNEL A



STAND
UN IT

Parameter	Setting	Description
Measurement units	UN IT	Displaying measurement units For a clear and user-customized display, the measured value can be assigned a unit corresponding to the physical quantity.
STAND	STAND	Standard display The display shows the measured value together with the unit corresponding to the selected range and type of measurement (max. 2 characters).
NO.UNIT	NO.UNIT	No unit Only digits without units are displayed on the screen.
USER	USER	User defined units The measured value is displayed with its own unit (letters or symbols) set in the following item <i>USE.DXT</i> (< 2 characters).



USE.DXT
CHANNEL A



A
USE.DXT

Parameter	Setting	Description
User units	USE.DXT	Setting of User defined unit For better orientation and clarity, you can add your own informative text to the measured value, which will be displayed on the secondary display. The unit can have a maximum of 2 characters



When either *STAND* and *USER* modes are selected, the projection of the measured value is limited to 4 digits (8888). The characters that can be used for these modes are listed on [page 84](#)

5.2.2h Description display selection - CHANNEL A

☰ INPUTS ▲ CHANNELS ✓ CLEAR ▲ CHANNEL A ✓ SOURCE 7x ▲ ESCR

ESCR
CHANNEL A



A
ESCR

Parameter	Setting	Description
Description	ESCR	Setting of additional description For better orientation and clarity, text can be added to the secondary display for the measured value, which improves the comprehension of the displayed information and adapts it to the requirements of a specific application or measurement. The text length is max. 6 characters

5. Device settings

5.2.2i Primary display color selection - CHANNEL A

≡ INPUTS ▲ CHANNELS ✓ CLEAR ▲ CHANNEL A ✓ SOURCE 8x ▲ COLOR

COLOR
CHANNEL A



RED
COLOR

Parameter	Setting	Description
Color selection	COLOR	Selection of Primary display color This function allows you to select the color of the measured value display on the primary display. The color of the secondary display is permanently green.
RED	RED	Red display color DEF
GREEN	GREEN	Green display color
ORANGE	ORANGE	Orange display color
3-BAND	3-BAND	Three-color display Allows automatic color change of the display depending on the displayed value. The limit values and colors for individual bands are set in the menu item BANDS



5.2.2j Setting of bands for the Primary display color change - CHANNEL A

≡ INPUTS ▲ CHANNELS ✓ CLEAR ▲ CHANNEL A ✓ SOURCE 9x ▲ BANDS

BANDS
CHANNEL A



COLOR.1
BANDS

Parameter	Setting	Description
Color change	BANDS	Settings the primary display color change Setting of parameters for automatic display color change depending on the displayed value. <i>This menu is only available when 3-BAND is selected in the COLOR menu item.</i>
COLOR.1	COLOR.1	Color setting below the 1st limit Color setting for values below the first limit Options: Red, Green, Orange.
LIMIT.1	LIMIT.1	Setting the 1st limit Setting the 1st limit value for the color change between the lower band and the middle band. Range: -99999...999999
COLOR.2	COLOR.2	Setting the color between the 1st and 2nd limits Setting the color for values between the 1st and 2nd limits. Options: Red, Green, Orange.
LIMIT.2	LIMIT.2	Setting the 2nd limit Setting the 2nd limit value for the color change between the middle band and the upper band Range: -99999...999999
COLOR.3	COLOR.3	Setting the color above the 2nd limit Setting the color for values above the 2nd limit. Options: Red, Green, Orange.



5.2.2k Setting the range of measured value recording - CHANNEL A

☰ INPUTS ^ CHANNELS ✓ CLEAR ^ CHANNEL A ✓ SOURCE 10x ^ REC.CFG

REC.CFG
CHANNEL A



ALL
REC.CFG

Parameter	Setting	Description
Recording range	REC.CFG	Setting the range of recorded measured values This function allows you to limit the recorded values based on the selected range, which facilitates subsequent data processing and analysis. <i>This menu is only available when YES is selected in the RECORD menu item..</i>
ALL	ALL	Recording of all values DEF All measured values are recorded in the memory without restriction.
INSIDE	INS # E	Recording values within the band Only values that fall within the preset band are stored into the memory. Limit values are set in the MIN / MAX item.
OUTSIDE	OUTS #	Recording values outside the band Only values that fall outside the preset band are stored into the memory. Limit values are set in the MIN / MAX item.



5.2.2l Setting the interval limit for recording of measured values - CHANNEL A

☰ INPUTS ^ CHANNELS ✓ CLEAR ^ CHANNEL A ✓ SOURCE 11x ^ REC.SET

REC.SET
CHANNEL A



MIN
REC.SET



00
MIN



00
MAX

Parameter	Setting	Description
Recording limit	REC.SET	Setting the limits to a recording interval This setting allows you to define the interval of values inside / outside of which values are recorded. <i>This menu is only available when INSIDE or OUTSIDE is selected in the REC.CFG menu item.</i>
MIN	MIN	Setting the lower limit of the interval Set the minimum interval value for recording Range: -99999...999999
MAX	MAX	Set the upper limit of the interval Set the maximum interval value for recording. Range: -99999...999999

5. Device settings

5.2.2m Selection of digital filters - CHANNEL A

≡ INPUTS ▲ CHANNELS ✓ CLEAR ▲ CHANNEL A ✓ SOURCE 12x ▲ FILTER

FILTER
CHANNEL



FILCFG
FILTER

Parameter	Setting	Description
Digital filters	FILCFG	Digital filter setting Digital filters allow you to adjust the data displayed on the screen so that the value is more stable and better suited for user's needs.
OFF	OFF	Filters are off DEF No mathematical adjustment of measured values is active.
AVER	AVER	Averaging of measured values According to the setting of the filter constant <i>F.CONST</i> , the arithmetic mean is calculated from 2 to 100 consecutive values. The arithmetic mean represents the typical value of a group of <i>F.CONST</i> measurements. The rate of filtered measurements is reduced to the sampling rate / <i>F.CONST</i> . This filter is suitable for suppressing fluctuations and short-term deviations of the measured value from its typical level.
FLAVER	FLAVER	Floating average According to the setting of the filter constant <i>F.CONST</i> , the floating average is calculated from 2 to 100 values. The calculation is performed over a buffer containing the last <i>F.CONST</i> measured samples. The rate of the filtered measurements is identical to the sampling rate. The floating average is used to smooth the measured curve and allows for better determination of the trend or a change in the trend of the measured signal. The value of the filter constant <i>F.CONST</i> can only be an integer.
EXPON	EXPON	Exponential filter According to the setting of the filter constant <i>F.CONST</i> , the filtered value is calculated as a weighted average of the previous filtered value and the newly measured value according to the following formula: $\frac{\{X \times (F.CONST - 1) + Y\}}{F.CONST}$ where X is the previous filtered value Y is the new measured value The rate of the filtered measurements is identical to the sampling rate. Using an exponential filter, changes in the input signal are reflected in the logarithmic progression of the output signal, where the rate of change of the output signal value is an exponential function of the difference in input signal values. The exponential filter causes changes in the input signal to be manifested as a smooth (exponential) progression of the output signal. The rate of change of the output depends on the magnitude of the difference between input values. This filter is particularly suitable for measuring transient processes, where it converts rapid changes in the input signal into a continuous progression. The value of the filter constant <i>F.CONST</i> can only be an integer.
ROUND	ROUND	Rounding of the measured value According to the setting of the constant <i>F.CONST</i> , the input value is rounded, according to mathematical rules, to the nearest lower or higher multiple of the <i>F.CONST</i> value. The rate of the filtered measurements is identical to the sampling rate. This filter ensures that the output value only takes defined levels, which are multiples of the value of <i>F.CONST</i> . The value of the filtering constant <i>F.CONST</i> can be any real number.



5.2.2n Setting the constant for digital filters

☰ INPUTS ▲ CHANNELS ✓ CLEAR ▲ CHANNEL A ✓ SOURCE 12x ▲ FILTER ▲ F.CONST

F I L T E R
CHANNEL



F I L T E R
F I L T E R



F . C O N S T
F I L T E R



10
F . C O N S T

Parameter	Setting	Description
Setting of constants	F.CONST	Setting of constants used in digital filters The set constant value determines the filter parameters and corresponds to the number, time, or value depending on which type of digital filter has been selected. Range: 2.....100 <i>This menu is only available when any digital filter except for OFF is selected in the FILTER menu (5.2.2n)</i>

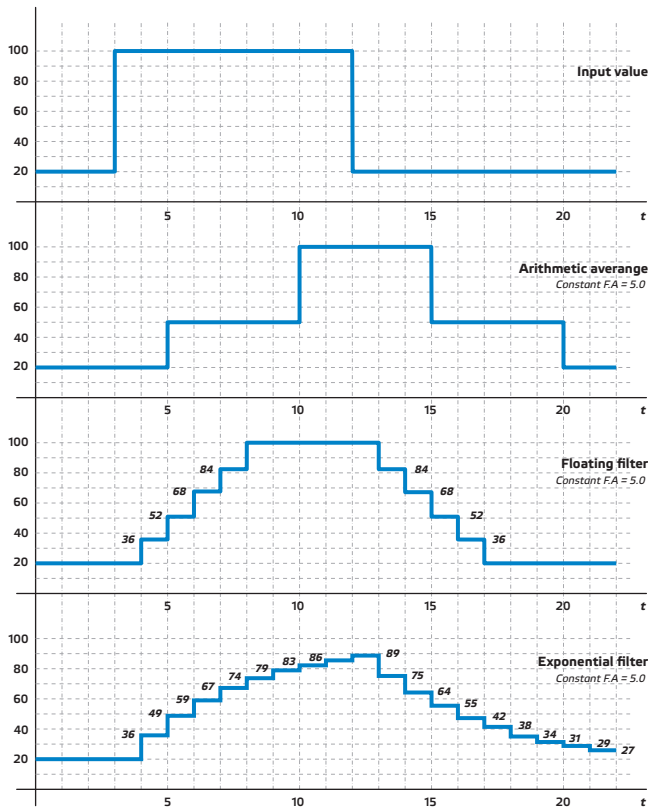

5. Device settings

5.2.2o Selection of mathematical functions - CHANNEL A

☰ INPUTS ▲ CHANNELS ✓ CLEAR ▲ CHANNEL A ✓ SOURCE 13x ▲ MATHFN

MATHFN
CHANNEL A



MATCFG
MATHFN



OFF
MATHCFG

Parameter	Setting	Description
Mathematical functions	MATHCFG	Mathematical Functions Selection Mathematical functions are used to process, modify, and interpret measured values. Their use allows the signal to be transformed into a form that corresponds to the needs of a specific application, sensor, or physical quantity. You can set the mathematical constant in items <i>CONSTA...F</i> .
	OFF	OFF Mathematical functions are disabled. DEF
	POLYN.	POLYN $Ax^5 + Bx^4 + Cx^3 + Dx^2 + Ex + F$ Polynomial Signal transformation based on polynomial dependence, for example for calibrating sensors with nonlinear characteristics.
	INV.POL	INV.POL Inverse polynomial $\frac{A}{x^5} + \frac{B}{x^4} + \frac{C}{x^3} + \frac{D}{x^2} + \frac{E}{x} + F$ Reversal of nonlinear dependence, where it is necessary to calculate the corresponding input variable from the displayed values, e.g., for reconstruction of the original signal from the transformed value.
	LOGAR	LOGAR Logarithm $A \times \ln\left(\frac{Bx+C}{Dx+E}\right) + F$ Logarithmic signal transformation, which is suitable for values with a large range or exponential growth, e.g., conversions of quantities to logarithmic scale, e.g., sound level (dB) or pH.
	EXPON	EXPON Exponential $A \times e^{\left(\frac{Bx+C}{Dx+E}\right)} + F$ Exponential signal transformation for modeling processes with exponential e.g., for analyzing growth and decay processes (radioactive decay, charging and discharging of capacitors) or modeling natural increase or decrease of variables.
	POWER	POWER Power $A \times (Bx + C)^{(Dx+E)} + F$ Increases signal values to a certain power, e.g. for calculating power (current squared for electrical power) or data transformation for physical quantities dependent on powers (e.g., area, kinetic energy).
	SQ.ROOT	SQ.ROOT Square root $A \times \sqrt{\frac{Bx+C}{Dx+E}} + F$ Calculates the square root of a signal, which is useful for normalizing or reducing the range of data, e.g., for calculating the root mean square (RMS) value or processing signals with quadratic dependence (e.g., converting energy to velocity).



5.2.2p Setting constants for mathematical functions

☰ INPUTS ▲ CHANNELS ✓ CLEAR ▲ CHANNEL A ✓ SOURCE 14x ▲ CONSTA

CONSTA
MATH.FN



CONSTA

Parameter	Setting	Description
Setting of constants	CONST.-	Setting of Constants for mathematical functions Up to 6 constants (A - F) can be set to determine the parameters of the mathematical function.
		<i>This menu is only available when selecting a function in the MATH.FN menu item.</i>



Settings for Constants B - F are identical to the settings for Constant A

5.2.2q Setting the deadband for the PEAK function

☰ INPUTS ▲ CHANNELS ✓ CLEAR ▲ CHANNEL A ✓ SOURCE 15x ▲ PEAK:b

PEAK:b
CHANNEL



PEAK:b

Parameter	Setting	Description
Insensitivity band of function PEAK	PEAK:b	Setting the insensitivity (deadband) of function PEAK It allows you to set the deadband for the PEAK function, which is used to capture the peak value of a signal. The deadband determines how much the measured value must drop for the currently held peak value to be considered valid and stored. This limits the response to minor fluctuations or noise in the measured signal. The higher the deadband value, the greater the change in the signal is required to capture the peak value. If the deadband is set to 0, the function will respond to even the slightest drop in the signal.

5.2.2r Linearization Table Settings

The linearization table is imported (CSV) or edited exclusively in the OM Link computer SW and transferred to the device via a USB-C cable or Bluetooth interface. The active linearization table is indicated on the device display by the + symbol.



A linearization table can be assigned to each channel. The total sum of all points in all tables must not exceed 300.

5.2.3 Settings for Channel B - C



Settings for Channels B - C are identical to those for Channel A

5. Device settings

5.3 Setting of FUNCTION

The FUNCTIONS menu is used to set the device's special functions.

5.3.1 Timer

This function allows you to set time or daily restrictions on the operation of the device or its individual functions and peripherals, such as relay outputs, analog outputs, data recording, or other active modes.

The device or its selected function will only be active at defined times and on defined days; outside this interval, it remains inactive (e.g., the relay is off, recording does not take place).

This is suitable for applications where time-scheduled device behavior is required, such as time-limited alarms, data recording only during work shifts, or output activation only during a specified interval.

Setting options

Time Setting the time window during which the device or its function will be active

Function Select the device function in the set time window

5.3.1a Setting the time window for TIMER 1

≡ INPUT5 ▲ ▲ FUNC1 ✓ ◀ TIMER ✓ ◀ TIMER.1 ▲ ▲ START

START
◀ TIMER.1



00:00:00
START

Parameter	Setting	Description
Start of time window	START	Time window setting It allows you to set the time period during which the device or its functions will be active.
	00:00:00	Setting the start time for the window Defines the start of the time window for the operation of the device or its selected peripherals.
		Setting range: 00:00:01...23:59:59

≡ INPUT5 ▲ ▲ FUNC1 ✓ ◀ TIMER ✓ ◀ TIMER.1 ▲ ▲ END

END
◀ TIMER.1



23:59:59
END

Parameter	Setting	Description
End of time window	END	Time window setting It allows you to set the time period during which the device or its functions will be active.
	23:59:59	Setting the time for the end of the window Defines the end of the operating window for the device or its selected peripherals.
		Setting range: 00:00:01...23:59:59



The Timer 2-3 settings are identical to the TIMER.1 settings.

☰ INPUTS ⬆️ ⬆️ FUNCt ✓ t IMER ✓ t IMER.1 ⬆️ ⬆️ ⬆️ ⬆️ R:5

R:5
t IMER.1



MOND A:
NO

✓ / ⬆️
YES - NO



Parameter	Setting	Description
Time window DAYS	R:5	Selecting active days for the time window It allows you to select specific days of the week during which the time window will be active.
MONDAY	MOND A:	Monday > YES - NO option
TUESDA	TUESD A	Tuesday > YES - NO option
WEDNES	WEDNES	Wednesday > YES - NO option
THURSD	THURSD	Thursday > YES - NO option
FRIDAY	FRID A:	Friday > YES - NO option
SATURD	SATURD	Saturday > YES - NO option
SUNDAY	SUND A:	Sunday > YES - NO option
Setting	YES - NO	Select active day For each day, you can set the selection using the ✓ and ⬆️ buttons. YES the selection is active NO selection is inactive



DEF

5.3.1b Selecting device functions inside the TIMER 1 time window

☰ INPUTS ⬆️ ⬆️ FUNCt ✓ t IMER ✓ t IMER.1 ⬆️ ⬆️ ⬆️ ⬆️ SELECT

SELECT
t IMER.1



MEMOR:
NO

Parameter	Setting	Description
Function selection	SELECT	Selecting which functions will be active inside the time window function determines how the device or its peripherals will operate in the set working window.
MEMORY	MEMOR:	Data recording Data recording function in the set time window > option YES - NO.
RELAY	RELA:	Relay outputs Relay output function in the set time window > option YES - NO.
ANALOG	ANALOG	Analog output Analog output function in the set time window > option YES - NO.
SERIAL	SERIAL	Data output Data output function in the set time window > option YES - NO.
EXT.INP	EXT. INP	External inputs External inputs function in the set time window > option YES - NO.
Setting	YES - NO	Selecting function For each item, you can use the buttons ✓ and ⬆️ to set the option: YES the device/peripheral function is active only inside the time window NO the device/peripheral function operates without restrictions even outside the time window



Availability of menu items MEMORY, RELAY, ANALOG, and SERIAL depends on the physical presence of the corresponding peripherals in the device.

DEF

5. Device settings

5.4 Setting of OUTPUTS

The Outputs menu is used for the configuration of all output functions of the measuring device. It allows you to set the ways the measured values are displayed on the screen, their analog transmission, and the controlling of relays. This makes it easy to adapt the device to a wide range of applications, from basic measurement and monitoring to complex automation and analytical systems.

The outputs provide flexibility in data transfer and processing, ensuring efficient work with measured values and their connection to other devices.

5.4.1 Relay/OC output

The relay or open collector (OC) output is a key component of the measuring device, enabling direct control of external devices based on measured values. Thanks to its versatility, the relay output is used in a wide range of applications in automation, control, and process monitoring.

Setting options

Source for relay Allows you to select the signal or value to which the relay will respond

Relay mode Selection from RISE, FALL, WINDOW and BATCH modes

Relay type Relay switching type options (i.e. NO, NC etc.)

Value Setpoint settings

5.4.1a Signal source selection for Relay 1

☰ INPUTS ▲ ▲ ▲ OUTPUT ✓ RELAY ✓ RELAY.1 ✓ INPREL



Parameter	Setting	Description
Signal source	INPREL	Selection of signal source for relay 1 This option allows you to define which input signal or value will control the relay functions
OFF	OFF	Relay 1 is off
VAL.A	VAL.A	Current value of Channel A [VALUE. B - C] DEF
MIN. A	MIN.A	Minimum value of Channel A [MIN. B - C]
MAX. A	MAX.A	Maximum value of Channel A [MAX. B - C]
PEAK A	PEAK.A	Peak value of Channel A [PEAK. B - C]
ABS. A	ABS.A	Absolute value of Channel A [ABS. B - C]
ERROR	ERROR	Error message Signalling of errors set in the service menu.



All options for Channels B and C are displayed only if they are active



The settings for Relays 2...6 are identical to the settings for Relay 1

5.4.1b Selecting the setpoint type for Relay 1

☰ INPUTS ▲▲▲ OUTPUT ✓ RELAY ✓ RELAY: 1 ✓ INPREL ▲ MODE

MODE
RELAY: 1



RISE
MODE

Parameter	Setting	Description
Relay mode	MODE	Selecting the mode for relay 1 A selection from relay modes allows you to select the most suitable setting for your specific application
RISE	RISE	Active above the set value The relay is active when the measured value reaches and exceeds the Setpoint. The relay is deactivated when the measured value falls below (Setpoint - Hysteresis). DEF
FALL	FALL	Active below the set value The relay is active when the input signal reaches and falls below the Setpoint. The relay is deactivated when the measured value rises above (Setpoint + Hysteresis).
WINDOW	WINDOW	Window setpoints The relay is activated when the measured value enters the range between the Start of the window and the End of the window. If Hysteresis is set, the relay remains active within this range and is deactivated when the value exceeds (Window End + Hysteresis) or falls below (Window Start - Hysteresis).
bATCH	BATCH	Batch mode The relay is activated for a user-set time <i>DURAT</i> every time a multiple of the measured value <i>PERIOD</i> is reached.



5.4.1c Switching type selection for relay 1

☰ INPUTS ▲▲▲ OUTPUT ✓ RELAY ✓ RELAY: 1 ✓ INPREL ▲▲ TYPE

TYPE
RELAY: 1



SW.ON
TYPE

Parameter	Setting	Description
Switching type	TYPE	Select the switching type for relay 1 A choice from several relay switching types allows you to select the most suitable setting for your specific application, ensuring flexible and precise control of connected devices.
SW. ON	SW.ON	Normally open (Form A) When not energized, contacts are open. When energized, contacts close. DEF
SW. OFF	SW.OFF	Normally closed (Form B) When not energized, contacts are closed. When energized, contacts open.
PULSE	PULSE	Pulse relay The relay closes shortly for a set amount of time (TIME menu) and then returns to its original state.
LATCH	LATCH	Latching (holding) relay with drop-out blocking (safety relay) After activation, the relay remains closed and can be opened only via an external (logic) input or by the press of a button on the front panel in accordance with the standard (IEC EN 61496).



5. Device settings

5.4.1d Setting setpoints for relay 1 > Mode: Increase/Decrease

≡ INPUTS OUTPUT RELAY RELAY 1 INP.REL SETPD 1

SETPD 1
RELAY 1



0
SETPD 1



HYS TER
RELAY 1



0
HYS TER



ON. DEL
RELAY 1



00
ON. DEL



OFF. DEL
RELAY 1



00
OFF. DEL

Parameter	Setting	Description
Setpoint setting	SETPD 1	Setting the setpoint for relay 1 Setting the value at which the relay is activated.
Setting range: -99999...999999		

Parameter	Setting	Description
Hysteresis setting	HYS TER	Hysteresis setting for relay 1 Hysteresis is used to restrict frequent switching of the relay when the signal fluctuates around the setpoint value. When <i>MODE</i> > <i>RISE</i> is set, the relay closes when the Limit value is exceeded and opens when the value falls below the Setpoint minus the Hysteresis value. When <i>MODE</i> > <i>FALL</i> is set, the relay closes when the value falls below the Setpoint value and opens when the Setpoint plus Hysteresis value is exceeded.
Setting range: 0...999999		

Parameter	Setting	Description
Switch-on delay	ON. DEL	Setting of Relay 1 switch-on delay The delay ensures that the relay does not respond immediately to short-term changes or interference in the input signal, thus enabling stable and effective control of connected devices.
Setting range: 0...99.9 s		

Parameter	Setting	Description
Switch-off delay	OFF. DEL	Setting of Relay 1 switch-off delay The delay ensures that the relay does not respond immediately to short-term changes or interference in the input signal, thus enabling stable and effective control of connected devices.
Setting range: 0...99.9 s		

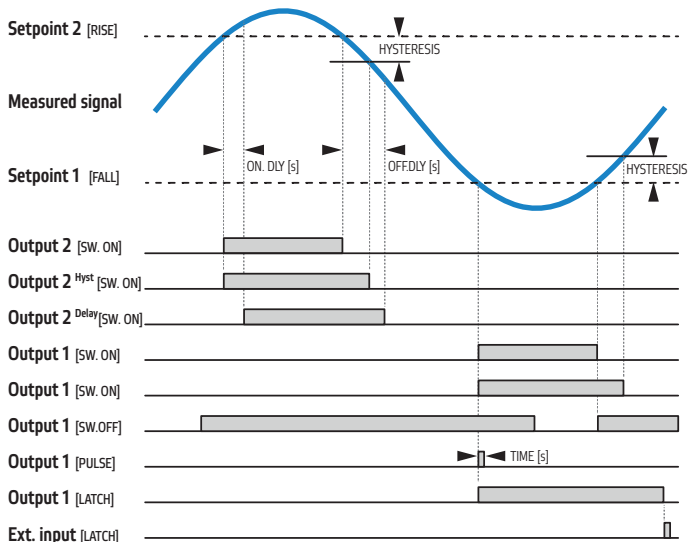

5.4.1e Setting setpoints for relay 1 > Mode: Window

☰ INPUTS ⬆ ⬆ ⬆ OUTPUT ✓ RELAY ✓ RELAY.1 ✓ INP.REL ⬆ ⬆ ⬆ W IN.LO

W IN.LO
RELAY.1



W IN.LO



W IN.HI
RELAY.1



W IN.HI

Parameter	Setting	Description
Setting of window start	W IN.LO	Setting of the window Start setpoint for relay 1 Lower end setpoint of the interval at which the relay becomes activated.
		Setting range: -99999...999999

Parameter	Setting	Description
Setting of window end	W IN.HI	Setting of the window End setpoint for relay 1 Upper end setpoint of the interval at which the relay is deactivated.
		Setting range: -99999...999999

5. Device settings

↑
HYSER
REL1



0
HYSER

Parameter	Setting	Description
Hysteresis setting	HYSER	Hysteresis setting for relay 1 Hysteresis is used to restrict frequent switching of the relay when the input signal fluctuates around the setpoint value.
		Setting range: -99999...999999

↑
ON:PL1
REL1



00
ON:PL1

Parameter	Setting	Description
Switch-on delay setting	ON:PL1	Setting of Relay 1 switch-on delay The delay ensures that the relay does not respond immediately to short-term changes or interference in the input signal, thus enabling stable and effective control of connected devices.
		Setting range: 0...99.9 s

↑
OFF:PL1
REL1



00
OFF:PL1

Parameter	Setting	Description
Switch-off delay setting	OFF:PL1	Setting of Relay 1 switch-off delay The delay ensures that the relay does not respond immediately to short-term changes or interference in the input signal, thus enabling stable and effective control of connected devices.
		Setting range: 0...99.9 s

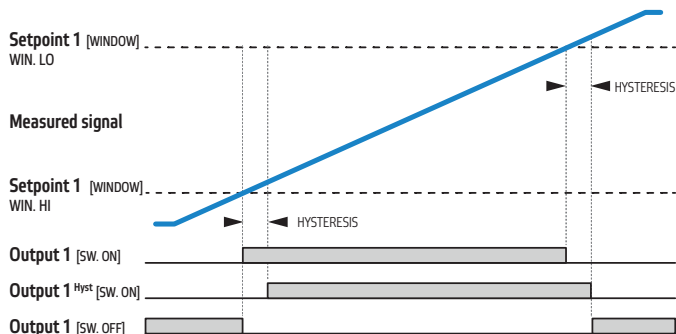

5.4.1f Setting limits for relay > Mode: Batch

☰ INPUTS ▲▲▲ OUTPUT ✓ RELAY: ✓ RELAY: 1 ✓ INP.REL ▲▲▲ PERIOD

PERIOD
RELAY: 1



0.0
PERIOD

Parameter	Setting	Description
Setting the multiple	PERIOD	Setting the activation period for relay 1 Relay will switch on for a specified duration of time (see menu item DURAT below) every time a multiple (PERIOD) of the input signal is reached. For example, as weight increases on a scale, the relay will periodically close shortly every five kilograms (5, 10, 15, 20 etc.) Setting range: 0...999999



DURAT
RELAY: 1



1.0
DURAT

Parameter	Setting	Description
Relay on-time	DURAT	Setting the time duration for which relay 1 stays closed Relay switch-on time. Setting range: 0...99.9 s



ON.DLY
RELAY: 1



Parameter	Setting	Description
Switch-on delay setting	ON.DLY	Setting of Relay 1 switch-on delay The delay ensures that the relay does not respond immediately to short-term changes or interference in the input signal, thus enabling stable and effective control of connected devices. Setting range: 0...99.9 s



Measured signal

Setpoint 1 [BATCH]
PERIOD

Output 1 [SW. ON]

Output 1 [SW. OFF]

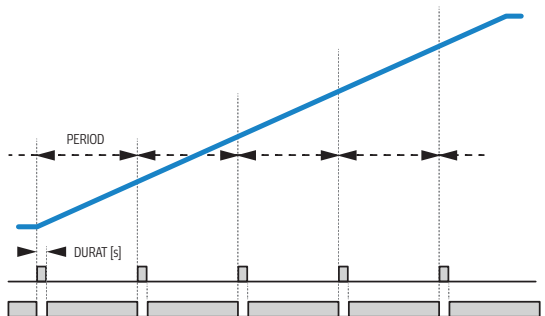

5. Device settings

5.4.2 Analog output

The analog output (active, no need for external power supply) converts measured values into a standard analog signal (voltage or current) that can be used in external devices such as programmable logic controllers (PLCs), data loggers, control units, or display devices. This output is essential for integrating the measuring device into automation and monitoring systems where it is necessary to share measured values in real time.

Setting options

- Source for AO Selection of the signal or value to be converted to analog output
 AO type Selection of the type and range of the analog output
 Min/Max AO Allows you to assign the beginning and end of the analog output range to display values

5.4.2a Selecting the signal source for the analog output

≡ INPUTS ⬆️ ⬆️ ⬆️ OUTPUT ✓ RELAY ⬆️ ANALOG ✓ INP.AO

INP.AO
ANALOG



VALUE.A
INP.AO

Parameter	Setting	Description
Signal source	INP.AO	Selecting the signal source for the analog output It allows you to define which input signal or value will be converted to analog output.
VALUE.A	VALUE.A	Actual value of Channel A [VALUE.B - C] DEF
MIN.A	MIN.A	Minimum value of Channel A [MIN. B - C]
MAX.A	MAX.A	Maximum value of Channel A [MAX. B - C]
PEAK.A	PEAK.A	Peak value of Channel A [PEAK. B - C]
Abs.A	Abs.A	Absolute value of Channel A [ABS. B - C]



All options for Channels B and C are displayed only if they are active

5.4.2b Analog output signal selection

≡ INPUTS ⬆️ ⬆️ ⬆️ OUTPUT ✓ RELAY ⬆️ ANALOG ✓ INP.AO ⬆️ t:PEAO

t:PEAO
ANALOG



4-20mA
t:PEAO

Parameter	Setting	Description
Output type	t:PEAO	Selecting the Analog output signal type and range It allows you to select the desired analog output signal type to match the specifications of the connected device.
2V	2V	0...2V
5V	5V	0...5V
10V	10V	0...10V
+10V	+10V	± 10V
5 mA	5mA	0...5 mA
20 mA	20mA	0...20 mA
4-20 mA	4-20mA	4...20 mA DEF



5.4.2c Assignment of the display value to the beginning of the analog output range

☰ INPUTS ▲▲▲ OUTPUT ✓ RELAY ▲ ANALOG ✓ INP.RD ▲▲ M IN.RD

M IN.RD
ANALOG



0
M IN.RD

Parameter	Setting	Description
Setting of Minimum value	M IN.RD	Value of the selected signal source for the beginning of the analog output range This option allows you to assign any value from the selected signal source, displayed on the screen, as the starting point of the range (minimum value) of the analog output.



Setting range: -99999...999999

5.4.2d Assigning a display value to the end of the analog output range

☰ INPUTS ▲▲▲ OUTPUT ✓ RELAY ▲ ANALOG ✓ INP.RD ▲▲▲ MR#.RD

MR#.RD
ANALOG



100
MR#.RD

Parameter	Setting	Description
Setting of Maximum value	MR#.RD	Value of the selected signal source for the end of the analog output range This option allows you to assign any value from the selected signal source, displayed on the screen, as the end point of the range (maximum value) of the analog output.



Setting range: -99999...999999



If the device is equipped with a second analog output, its settings are available in the *ANALG.2* item.

The configuration of the second output is identical to that of the main analog output, available in the *ANALOG* item.

5. Device settings

5.4.3 Display

This part of the menu allows you to customize the overall display settings, including brightness and the selection of values displayed in individual parts of the display.

Setting options

- Brightness** Adjust the overall brightness of the display to optimize readability in different lighting conditions.
- Primary display** Select the input value to be displayed on the primary display
- Secondary display** Select the input value to be displayed on the secondary display
- Bar graph** Setting of the bar graph
Select the input value and the display type (standard bar, zero in the middle, point)
Define the bar graph range for a clear visual display of measured values.

5.4.3.1 Display brightness Setting

≡ INPUTS ▲ ▲ ▲ ▲ OUTPUT ✓ RELAY ▲ ▲ ▶ ISP. ✓ BRIGHT



Parameter	Setting	Description
Brightness settings	BRIGHT	Display brightness selection The display brightness setting allows you to adjust the display to the current lighting conditions at the installation site, ensuring optimal readability and energy efficiency.
AUTO	AUTO	Automatic display brightness control The display brightness is continuously adjusted to the level of ambient lighting using a built-in sensor.
SLEEP	SLEEP	Display is off The display is off but will light up automatically for 60 seconds when any front panel button is pressed.
10%	10%	Display brightness is 10 % Minimum brightness, ideal for dark environments.
25%	25%	Display brightness is 25 % Significantly reduced brightness for twilight or nighttime operation.
50%	50%	Display brightness is 50 % Half brightness, suitable for dim lighting conditions.
75%	75%	Display brightness is 75 % DEF Slightly reduced brightness for normal lighting conditions.
100%	100%	Display brightness is 100 % The display is at full brightness, suitable for very bright environments.



5.4.3.2a Selecting the source of the displayed value for the primary display

☰ INPUTS ▲▲▲▲ OUTPUT ✓ RELAY ▲▲▲ ISP ✓ BRIGHT ▲ PR IMAR ✓ SOURCE

SOURCE
PR IMAR



VALUE.A
SOURCE

Parameter	Setting	Description
Display source	SOURCE	Selecting the source of the value displayed on the primary display This option allows you to set which input signal or value will be displayed on the primary display. The displayed value is determined by the settings in the INPUT menu and its parameters in the CHANNS menu.
VALUE.A	VALUE.A	Actual value of Channel A [VALUE.B - C] DEF Displays the currently measured value taken from Channel A
MIN.A	MIN.A	Minimum value of Channel A [MIN. B - C] Displays the lowest measured value of Channel A until it is reset by the CL.M.M function via a button or external signal.
MAX.A	MAX.A	Maximum value of Channel A [MAX. B - C] Displays the highest measured value of Channel A until it is reset by the CL.M.M function using a button or external signal.
PEAK.A	PEAK.A	Peak value of Channel A [PEAK. B - C] Displays the permanently stored peak value of channel A, which is captured only during the first rise or fall of the measured value and remains displayed without further updating until it is reset using the CL.PKA function, either via a button or an external signal. Unlike the MIN/MAX functions, which can record any number of new minimum or maximum values during measurement, the peak value is stored only once and does not change once it has been captured.
ABS.A	ABS.A	Absolute value of Channel A [ABS. B - C] Displays the absolute value of the current signal from Channel A (regardless of its mathematical sign).



All options for Channels B and C are displayed only if they are active

5.4.3.2b Option to switch between values displayed on the primary display

☰ INPUTS ▲▲▲▲ OUTPUT ✓ RELAY ▲▲▲ ISPL ✓ BRIGHT ▲ PR IMAR ✓ SOURCE ▲ SW: ISP

SW: ISP
PR IMAR



OFF
SW: ISP

Parameter	Setting	Description
Display source	SW: ISP	Switching between values displayed on the primary display This setting enables sequential display of selected measurement channels on the primary display. Only channels that have this option enabled in the SHOW menu are displayed.
OFF	OFF	Value switching is disabled Displays the current measured value from SOURCE menu. DEF
MANUAL	MANUAL	Manual switching of values on the display Value switching is controlled by the selected button on the front panel.
AUTOM	AUTOM	Automatic switching of values on the display Automatic with a time interval set in the INTERV menu.



5. Device settings



Parameter	Setting	Description
Switching interval setting	INTERV	Setting the time interval for sequential switching of displayed values Setting the time interval for displaying values in automatic input switching mode <i>AUTO</i> Setting range: 1...60 s



The *SW:DISP* (Switching between displayed information) menu is accessible only if 2 or more channels are active.

5.4.3.3a Selection of the source of the displayed value for the secondary display

≡ INPUTS ▲ ▲ ▲ ▲ OUTPUT ✓ RELAY ▲ ▲ ▲ ISP ✓ BRIGHT ▲ ▲ SECOND ✓ SOURCE



Parameter	Setting	Description
Display source	SOURCE	Selecting the source of the displayed value for the second. display As with the primary display, this option allows you to set which input signal or value will be displayed on the secondary display. However, the secondary display is mostly intended for displaying complementary information such as units of measure, text, time, electrical values, setpoints or other specific information.
	OFF	Display is off Secondary display is off DEF
	VALUE.A	Actual value of Channel A [VALUE.B - C]
	MIN.A	Minimum value of Channel A [MIN. B - C]
	MAX.A	Maximum value of Channel A [MAX. B - C]
	PEAK.A	Peak value of Channel A [PEAK. B - C]
	ABS.A	Absolute value of Channel A [ABS. B - C]
	TARE.A	Tare value [TARE. B - C] Displays the current tare value for the selected channel.
	GROSS.A	Tare value + Channel A [GROSS.B - C] Displays the gross value, i.e., the total measured signal (Channel A value + tare value)

↓↓↓

SOURCE
SECONDOFF
SOURCE

CUMULA	CUMUL.A	Cumulative sum [CUMUL.B - C] Displays the current value of the cumulative sum.
SETPOI	SETPOI	Display of the setpoint Displays the current value of the setpoint(s) corresponding to the channel displayed on the primary display.
ANALOG	ANALOG	Actual value of analog outputs Displays the current value of analog output .1 or 2.
DESCRI	DESCR	User-defined description of the displayed channel Description of the channel or function displayed on the primary display.
TIME	TIME	Current time Displays the current time controlled by the internal RTC (Real-Time Clock).
DATE	DATE	Current date Displays the current date controlled by the internal RTC.



All options for Channels B and C are displayed only if they are active

5.4.3.4a Selection of the source of the displayed value for the bar graph

INPUTS ↑↑↑↑ OUTPUT ✓ RELAY ↑↑↑ ISP ✓ BRIGHT ↑↑↑ BARGRA ✓ SOURCE

SOURCE
BARGRAOFF
SOURCE

Parameter	Setting	Description
Bargraph source	SOURCE	Selection of the source of the displayed value for the bargraph This option allows you to set which input signal or value will be represented by the bar graph. The displayed value is determined by the settings in the <i>INPUT</i> menu and its parameters in <i>CHANN</i> s menu.
OFF	OFF	The bargraph is off The bargraph is deactivated DEF
VAL. A	VALUE.A	Actual value of Channel A [VALUE.B - C]
MIN. A	MIN.A	Minimum value of Channel A [MIN. B - C]
MAX. A	MAX.A	Maximum value of Channel A [MAX. B - C]
PEAK A	PERI.A	Peak value of Channel A [PEAK. B - C]
ABS. A	ABS.A	Absolute value of Channel A [ABS. B - C]



All options for Channels B and C are displayed only if they are active

5. Device settings

5.4.3.4b Selection of bar graph display mode

≡ INPUTS OUTPUT RELAY: ISP: BRIGHT 3x BARGR SOURCE MODE

MODE
BARGR



BAR
MODE

Parameter	Setting	Description
Display type	MODE	<p>Selecting the display mode for the bar graph</p> <p>This option allows you to customize the bar graph display mode to best suit the requirements of your application. The bar graph provides the user with an immediate and clear overview of where the current value is located within the measuring range.</p> <p>The bar graph also includes a scale for better orientation within the measuring range.</p>
	BAR	<p>Bar DEF</p> <p>The measured value is represented by a bar that expands from left to right. It is suitable for a quick visual overview of the entire measuring range.</p>
	CENTER	<p>CENTER</p> <p>Symmetrical bar graph that starts from the center (zero) and expands either to the left or to the right.</p> <p>Ideal for measurements with positive and negative values, e.g. ± ranges.</p>
	POINT	<p>POINT</p> <p>Point display</p> <p>The display shows a single point indicating the position of the current value on the scale.</p> <p>Suitable for applications where a visual localization within the measuring range is important.</p>



5.4.3.4c Display settings for the start of the bar graph range

≡ INPUTS 3x OUTPUT RELAY: ISP: BRIGHT 3x BARGR SOURCE 2x BARM IN

BARM IN
BARGR



4
BARM IN

Parameter	Setting	Description
Minimum setting	BARM IN	<p>Setting the bar graph corresponding to the minimum value of the input signal</p> <p>It enables you to assign the minimum input signal value to the beginning of the bar graph.</p> <p>Setting range: -99999...999999</p>



5.4.3.4d Display settings for end of bar graph range

☰ INPUTS 3x ▲ OUTPUT ✓ RELAY: ▲ ▲ ▶ ISP ✓ BAR IGH 3x ▲ BARGRA ✓ SOURCE 3x ▲ BARMA :

BARMA :
BARGRA



20
BARMA :

Parameter	Setting	Description
Maximum setting	BARMA :	Setting the bar graph corresponding to the maximum value of the input signal It enables you to assign the maximum input signal value to the end of the bar graph Setting range: -99999...999999

5.4.3.5a Indication of measured signal trend

☰ INPUTS 3x ▲ OUTPUT ✓ RELAY: ▲ ▲ ▶ ISP ✓ BAR IGH 4x ▲ TREND

TREND
: ISP



NO
TREND :

Parameter	Setting	Description
Trend display	TREND :	Setting of the measured signal trend display The trend display function is designed to monitor the stability and direction of change of the measured signal. It allows the operator to easily recognize whether the value is stabilizing, increasing, or decreasing, thereby facilitating process adjustments, calibration, weighing, or long-term monitoring of signals where evaluating the trend is more important than the instantaneous value itself.
	NO	The trend is not displayed The pictograms are off. DEF
	YES	The trend is displayed During trend evaluation, the measured values are stored in a floating buffer of 10 values, at a maximum rate of 20 times per second. The average value of the last five samples is compared with the average value of the previous five samples. If the difference between these averages is smaller than the allowed deviation eight times in a row, the measured value is evaluated as stable. Otherwise, an upward or downward trend is displayed. Permissible deviation is: <ul style="list-style-type: none"> ±0.25% of range ±¼ division when weighing functions are enabled <ul style="list-style-type: none"> ▲ The measured values show an increasing trend ▼ The measured values show a decreasing trend ▲ ▲ Equilibrium state* - the value is stable and within permissible deviation limits.



*This option is available only when Weighing functions are enabled (W_FUNC>YES)

5. Device settings

5.4.4 Memory

Recording measured data is a key function for monitoring, analyzing, and archiving measured values in real time as well as retrospectively. It allows you to track long-term trends, identify deviations, and optimize operational processes. With the option to set different recording modes, such as time-controlled recording, one-time recording, or pre-trigger recording, this device is suitable for a wide range of applications, from industrial automation to laboratory measurements. The stored data can then be analyzed, exported, and further processed to ensure efficient operation and error prevention.

Setting options

Record source	Selection of channels from which data is recorded
Record type	Select the type of data record to the device memory
Period	Select the time period for data recording (available when the PERIOD recording type is selected) with the option of time or day scheduling.
Overwrite	Select what should happen when the memory is full
Delete	Option to delete stored data

5.4.4a Permission to record measured values

☰ INPUTS ▲ ▲ ▲ OUTPUT ✓ RELAY ▲ ▲ ▲ MEMORY ✓ RECORD



YES - NO



Parameter	Setting	Description
Permission to record	RECORD	Selection of channels to be recorded Used to select channels for which it is possible to enable the recording of measured data in the menu. Only active channels are displayed in the menu. <i>This menu is only available on devices that support this function.</i>
CHANN. A	CHANN. A	Selection of record for Channel A > options YES - NO.
CHANN. b	CHANN. b	Selection of record for Channel B > options YES - NO.
CHANN. C	CHANN. C	Selection of record for Channel C > options YES - NO.
Setting	YES - NO	Selection of channels to be recorded For each active channel, you can use the buttons ▼ and ▲ to set the option: YES data recording is on NO data recording is off

DEF

☰ → 📄 ✓ → 📄

All options for Channels B and C are displayed only if they are active



The menu displays only active measurement Channels.
An active Channel has a set value in the SOURCE item (CHANNEL menu).

5.4.4b Selecting the method of recording values to the device memory

☰ INPUTS ▲▲▲▲ OUTPUT ✓ RELAY ▲▲▲▲ MEMORY ✓ RECORD ▲ MEMCFG

MEMCFG
MEMORY



PERIOD
MEMCFG

Parameter	Setting	Description
Record type	MEMCFG	Select the method for recording values to the device memory. It allows you to define how measured values are saved into the device memory according to specific user requirements.
PERIOD	PERIOD	Time-controlled record of values DEF Measured values are saved at predefined time intervals. It is possible to create a schedule (individual days and times) when recording is active/inactive.
MAXI	MAXI	Maximum recording speed Values are saved at the highest possible speed corresponding to the selected measurement rate. Measurement rate setting <i>INPUT>AN.INP>RATE</i>
SINGLE	SINGLE	Saving a single value (Single) of the present value A single measurement is saved every time a user-assigned button is pressed or external (logic) input is activated.
TRIGG.	TRIGG.	Data recording with Pre-trigger Values are saved continuously at maximum speed, same as with the MAX.SPD (Maximum recording speed) option. Upon receiving a control signal, values that follow are stored only into the section of the memory designated by the <i>PRE.TRG</i> menu setting, in order to preserve a defined portion of the previous values.



5.4.4c Recording settings for the option PERIOD

☰ INPUTS ▲▲▲▲ OUTPUT ✓ RELAY ▲▲▲▲ MEMORY ✓ RECORD ▲▲ PERIOD

PERIOD
RECORD



00:00:10
PERIOD

Parameter	Setting	Description
Setting of period	PERIOD	Setting of record when the type PERIOD is selected The set time interval defines the period at which the measured data will be saved into the device memory.
	00:00:10	Setting of the period After the set time interval has elapsed, the presently measured value is saved into the device memory together with the corresponding time/date stamp.
		Setting range: 00:00:01...23:59:59



5. Device settings

5.4.4d Selecting the method for saving values into the device memory

≡ INPUTS ▲▲▲▲ OUTPUT ✓ RELAY ▲▲▲ MEMOry ✓ RECORD ▲▲▲▲ OVERWR

OVERWR
MEMOry



NO
OVERWR

Parameter	Setting	Description
Record overwrite	OVERWR	Selecting the method of saving values into the device memory This function determines how the device will respond when the memory is full and allows you to set the data recording behavior to ensure continuous or controlled storage of values.
	NO	Overwriting of the oldest stored values is disabled When the memory becomes full, recording of values stops and an error message ERR.32 is displayed. This protects the already stored data from being accidentally overwritten. This mode is suitable for situations where it is crucial to preserve a complete record of measurements.
	YES	Overwriting of the oldest stored values is enabled DEF Once the memory is full, the oldest records are overwritten in a cyclical manner with new data. This mode allows continuous recording of values, but older values are irreversibly overwritten and lost. This mode is ideal for long-term monitoring with a focus on recent and current values.



REC

Lit The device is in a recording standby mode.
Flashing Active recording to memory is in progress.

5.4.4e Selecting memory for storing measured data

≡ INPUTS ▲▲▲▲ OUTPUT ✓ RELAY ▲▲▲▲ MEMOry ✓ RECORD 4x ▲ SAVE

SAVE
MEMOry



DEVICE
SAVE

Parameter	Setting	Description
Storage selection	SAVE	Selecting the media to which the measured data will be stored This function allows you to select the destination storage location for the measured values. The user can choose between the internal memory of the device and external USB storage, depending on the specific data recording requirements.
	DEVICE	Saving to the internal memory DEF The measured data is saved in the device's internal memory, where it is securely stored for later transfer and processing. The data cannot be viewed directly on the device's display, but it can be transferred via a data comm. line or via Bluetooth (BT) to the OM Link SW for further analysis and processing on an external device (e.g., a computer).
	USB	Saving to USB Flash The measured data is stored on an external USB flash drive connected via the USB-C connector on the back side of the device. The data can be opened and analyzed in the OM Link SW, or further processed in CSV format in spreadsheet processors such as Microsoft Excel or Google Sheets, and other analytical tools. This method of storage allows quick access to data and easy transfer between devices and effective archiving for long-term storage.



5.4.4f Deleting stored data from the device memory

☰ INPUTS ▲▲▲▲ OUTPUT ✓ RELAY ▲▲▲▲ MEMORY ✓ RECORD 5x ▲ ELETE

ELETE
MEMORY



NO
ELETE

Parameter	Setting	Description
Delete record	ELETE	Deleting stored data from the device memory This function allows you to delete all stored data permanently and irreversibly from the device memory. This ensures a clear and secure data deletion process, minimizes the risk of error, and provides the user with an overview of the operation status.
	NO	Deletion of stored data is prohibited. DEF Two-level confirmation serves as protection against accidental deletion of important data.
	YES	Deletion of stored data After confirming the action, all stored data will be irrevocably deleted from the device memory. The deletion process is visually indicated by a bar graph on the display, which shows the status and progress of the process



5.4.4g Setting the storage of values in TRIGGER mode

☰ INPUTS ▲▲▲▲ OUTPUT ✓ RELAY ▲▲▲▲ MEMORY ✓ RECORD 6x ▲ PRETRG

PRETRG
MEMORY



1/2.MEM
PRETRG

Parameter	Setting	Description
Pre-Trigger	PRETRG	Setting for saving values in TRIGGER mode Setting the size of allocated memory for saving values before the trigger signal
	NO	No values No values prior to the trigger signal are saved into the memory
	1/4.MEM	1/4 memory size 1/4 of the memory is allocated to values before the trigger signal and 3/4 for values after the trigger.
	1/2.MEM	1/2 memory size DEF 1/2 of the memory is allocated to values before the trigger signal and 1/2 for values after the trigger.
	3/4.MEM	3/4 memory size 3/4 of the memory is allocated to values before the trigger signal and 1/4 for values after the trigger.
	ALL	All pre-trigger values Only values preceding the trigger signal are saved.



Reading stored data

Stored data can be read from the device's memory using the OM Link SW running on a PC via a USB-C cable or Bluetooth connection. In the OM Link SW, the data can be clearly displayed and then exported to a CSV file for further processing.

5. Device settings

5.5 Settings of COMMUNICATION

Data output enables the transfer of measured values and other information to external devices such as PLCs, computers, or control systems. Standards such as RS-232, RS-485, Modbus RTU, TCP/IP, and PROFINET ensure compatibility and reliable communication even in industrial environments.

5.5.1 Data output RS 232/485

Setting options

Protocol	Communication protocol selection
Rate	Baud rate selection
Format	Format selection
Address	Device address setting

5.5.1a Communication protocol selection

≡ INPUTS 4x ▲ COMMUN ✓ RS 485 ✓ PROTOCOL

PROTOCOL
RS485



MODBUS
PROTOCOL

Parameter	Setting	Description
Protocol	PROTOCOL	Communication protocol selection Specifies the rules for data transmission and interpretation.
ASCII	ASCII	ASCII
MODBUS	MODBUS	MODBUS - RTU DEF
OM.COMM	OM.COMM	Company protocol for communication with OM devices



5.5.1b Data output baud rate selection

≡ INPUTS 4x ▲ COMMUN ✓ RS 485 ✓ PROTOCOL ▲ BAUD

BAUD
RS485



19200
BAUD

Parameter	Setting	Description
Rate	BAUD	Transmission rate selection Defines the number of bits transferred per second (bps).
19200	19200	Baud rate 19200 Baud DEF
Value selection		600 / 1 200 / 2 400 / 4 800 / 9 600 / 19 200 / 38 400 / 57 600 / 115 200 / 230 400 / 460 800 / 921 600



5.5.1c Select number of stop bits

☰ INPUTS 4x ⤴ COMMUN ✓ RS 485 ✓ PROTECT ⤴ ⤴ STOP.bE

STOP.bE
RS 485



!
STOP.bE

Parameter	Setting	Description	
Number of stop bits	STOP.bE	Select the number of stop bits Number of bits that indicate the end of a data frame.	
	1	1 stop bit	DEF
	1,5	1,5 stop bits	
	2	2 stop bits	

☰ → ✓ →

5.5.1d Stop bit parity selection

☰ INPUTS 4x ⤴ COMMUN ✓ RS 485 ✓ PROTECT ⤴ ⤴ ⤴ PARR.bE

PARR.bE
RS 485



NO.PAR
PARR.bE

Parameter	Setting	Description	
Parita	PARR.bE	Parity selection Used to detect errors in transmitted data.	
	NO.PAR	No parity	DEF
	EVEN	Even parity	
	ODD	Odd parity	

☰ → ✓ →

5.5.1e Device address setting

☰ INPUTS 4x ⤴ COMMUN ✓ RS 485 ✓ PROTECT 4x ⤴ ADDR.RES

ADDR.RES
RS 485



!
ADDR.RES

Parameter	Setting	Description
Address	ADDR.RES	Device address settings Device ID number in case of multiple connected devices.
		Setting range: 0...99 (RS 485) 1...247 (Modbus RTU)

←



RS 485

This text changes depending on the type of data output used (RS 232, RS 485, Modbus TCP/IP, PROFINET, Et. Cat, etc.).

5. Device settings

5.5.2 Data Output MODBUS TCP/IP

You can find the description of the protocol on our website www.orbitmerret.eu/en/om-403uni#download

Settings Options

DHCP	DHCP option
IP address	Display device IP address
MAC address	Display device MAC address

5.5.2a DHCP Selection

≡ INPUTS 4x ▲ COMMUN ✓ EETHERN ✓ ▽ HCP

HCP
EETHERN



YES
HCP

Parameter	Setting	Description
Rate	HCP	DHCP Selection It is used for turning on or off the automatic assignment of network parameters (IP address, subnet mask, default gateway, DNS) from a DHCP server. When DHCP is disabled, network parameters need to be set manually.
YES	YES	Automatic entry Network parameters are assigned automatically. DEF
NO	NO	Manual entry Network parameters are set manually (only using the OM Link program).



5.5.2b Displaying the device's IP address

≡ INPUTS 4x ▲ COMMUN ✓ EETHERN ✓ ▽ HCP ▲ IP.A: P

IP.A: P
EETHERN



128.242
IP.A: P

Parameter	Setting	Description
IP adresa	IP.A: P	Displaying the device's IP address Displays the currently assigned IP address of the device for network communication. Address change is only possible in the OM Link program when the DHCP function is turned off.

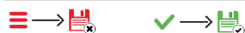

5.5.3b Displaying the device's MAC address

≡ INPUTS 4x ▲ COMMUN ✓ EETHERN ✓ ▽ HCP ▲ ▲ MAC.A: P

MAC.A: P
EETHERN



3b.2E:BF
MAC.A: P

Parameter	Setting	Description
MAC adresa	MAC.A: P	Displaying the device's MAC address Displays the unique MAC address of the device, which is used to identify it during communication.



5.5.3 Bluetooth

The device is equipped with a Bluetooth wireless interface that allows for easy and fast communication with smart devices or a computer. This feature can be used to wirelessly configure the device, monitor current measured values, perform diagnostics, and manage stored data.

Settings options

Activation Activation of Bluetooth communication

MAC address Display device MAC address

5.5.3a Turning on Bluetooth communication

☰ INPUTS 4x ⬆ COMMUN. ✓ RS 485 ⬆ BLUE. ✓ BLUE.ON

BLUE.ON
BLUE.



YES?
BLUE.

Parameter	Setting	Description
Turn on Bluetooth	BLUE.ON	Turn on the Bluetooth communication It is used for turning on the Bluetooth interface directly from the device menu. For faster activation, you can use a shortcut – press the ⬆ and ⬆ buttons simultaneously. CON flashes BT is active but not connected CON is lit After successful connection to PC
YES?	YES?	A prompt to activate the Bluetooth



5.5.3b Displaying the Bluetooth MAC Address

☰ INPUTS 4x ⬆ COMMUN. ✓ RS 485 ⬆ BLUE. ✓ BLUE.ON ⬆ MAC.A:R

MAC.A:R
BLUE.



4F:3E:2A
MAC.A:R

Parameter	Setting	Description
MAC adresa	MAC.A:R	Displaying the Bluetooth MAC Address Displays the unique identification address of the device's Bluetooth interface. This address is used to uniquely identify the device during pairing and communication.



Bluetooth communication can only be activated if you have already set a device password (≠0)



The time-out for Bluetooth communication is fixed at 2 minutes

5. Device settings

5.6 Setting of SERVICE

The Service menu provides advanced settings and configuration options for the device, allowing you to optimize its operation, customize its behavior to specific requirements, and perform diagnostics or maintenance. This menu is primarily intended for service technicians and experienced users who need access to more advanced system settings.

Settings options

Password	Set a password for accessing the menu and connecting to the device
Delayed state	Set the time [s] when no measurement is performed after connecting the device to the power supply
Settings	Save, upload, or return to the device's factory default settings
Calibration	Return to factory calibration (after user calibration was performed using a script in the OM Link SW)
Date, time	Setting the current date and time
Language	Selecting the language version of the menu
Errors	Selecting errors that will be signaled by LEDs on the front panel and by analog output
Wizard	Repeated launch of the setup wizard
Simulation	Simulation of input signal
Info	Device information (FW version, number of power-ups, running hours, etc.)

5.6.1 Setting a password for accessing the device menu

≡ INPUTS 5x ⤴ SERVICE IC ✓ PASSW#



Parameter	Setting	Description
Password setting	PASSW#	Password settings for accessing the device menu It allows you to secure access to the device menu and the OM Link SW when connected via a USB-C connector. The set password applies to both access to the device menu and connection using the OM Link SW. If the password is set to 0000, access to the menu is unrestricted and the device does not require any authentication.
	0000	Setting a new password You can change the password at any time to any value between 0000..9999

5. Device settings

5.6.5 Return to factory settings

☰ INPUTS 5x ▲ SERVICE 1C ✓ PASSWORD 4x ▲ FACTS.E

FACTS.E
SERVICE



YES?
FACTS.E

Parameter	Setting	Description
Obnova	FACTS.E	Return to factory settings This function allows you to restore the device factory default settings, thereby deleting all user configurations and parameters. The factory settings represent the original, manufacturer-preset state, which ensures optimal operation of the device.
YES?	YES?	Reset device After confirming the YES? prompt, the device will restart and automatically load the factory settings set by the manufacturer.



5.6.6 Deleting user calibration

☰ INPUTS 5x ▲ SERVICE 1C ✓ PASSWORD 5x ▲ CLR.CAL

CLR.CAL
SERVICE



YES?
CLR.CAL

Parameter	Setting	Description
Clear user calibration	CLR.CAL	Restoration of factory calibration This function allows you to restore the device's default factory calibration if the user calibration was performed incorrectly or applied incorrectly. User calibration is performed by running a script in the OM Link SW.
YES?	YES?	Clearing user calibration After confirming the YES? prompt, the user calibration will be deleted and the original factory calibration values set by the manufacturer will apply.



Restart after factory reset or after restoration of factory calibration

After loading the original settings, restoring the factory settings, or restoring the factory calibration, it is necessary to disconnect the device from the power supply and a USB cable.

This ensures that all changes in the device system are loaded and activated correctly.

5.6.7 Date settings

☰ INPUTS 5x ▲ SERV: IC ✓ PASSW: 6x ▲ : ALE



Parameter	Setting	Description
Date setting	: ALE	Setting the current date in the device This function allows you to set the current date in the device to ensure the correct time stamp for logged statuses or data records.
	00:00:00	Setting the current date
		Format: dd.mm.yy

5.6.8 Current time settings

☰ INPUTS 5x ▲ SERV: IC ✓ PASSW: 7x ▲ : TIME



Parameter	Setting	Description
Time setting	: TIME	Setting the current time This function allows you to set the exact time in the device to ensure the correct time stamp for logged statuses or data records. The time in the device is controlled by an RTC (Real-Time Clock) circuit, the accuracy of which may be affected by environmental conditions. The time can be conveniently synchronized using the OM Link SW, which automatically compares the time with a PC. If a difference is detected, the program prompts the user to make a correction.
	00:00:00	Setting the current time
		Format: 23:59:59

5.6.9 Selecting the menu language

☰ INPUTS 5x ▲ SERV: IC ✓ PASSW: 8x ▲ LANG.

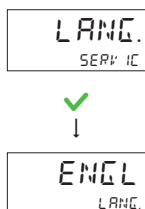

Parameter	Setting	Description
Language selection	LANG.	Device menu language selection It allows you to set your preferred language version of the device menu, making it easier to use and improving user comfort.
	ENGL.	English DEF
	ESPA.	Español
	FRANC.	Français
	DEUTS.	Deutsch
	ČESKY	Čeština
	USER	User dictionary Using the Menu Translator SW program, users can create their own language menus and then import them into the device using the OM Link SW. It is also possible to import existing language dictionaries that are compatible with the device.



5. Device settings

5.6.10 Selection of signaled error states

≡ INPUTS 5x ▲ SERVICE 1C ✓ PRESSURE 9x ▲ ERRORS 1G

ERRS 1G
SERVICE 1C



RNG.OVR
01 ERR

✓/▲
YES - NO



A/D.OVR
02 ERR

✓/▲
YES - NO



T/C.CJC
56 ERR

✓/▲
YES - NO

Parameter	Setting	Description
Error signaling	ERRS 1G	Selection of signaled error states Allows you to select errors that will be indicated by a red ERR LED and an error number on the orange display. The error status is also transmitted via the analog output (if present) for detection by an external system.
01	RNG.OVR	Input signal range exceeded by ±10% Change the input signal value or input settings (range)
02	A/D.OVR	ADC converter overflow/underflow Change the input signal value or input settings (range)
03	SENSOR	Sensor cable broken Check the cable and sensor connection (RTD, OHM).
04	bROK.tC	Thermocouple wire broken Check the cable and sensor connection.
05	LOOPIN	4-20 mA input current loop is broken Check the cable and sensor connection.
10	LOOPOU	Output current loop is broken Check the cable and current loop connection.
20	MATH.FN	Mathematical function error Change the mathematical function settings.
21	LIN.tAB	Linearization table error Change/add linearization table settings.
31	RTC	RTC error Set the date and time.
32	MEM.1	Full memory for data recording Transfer measured data, clear memory, or set automatic overwriting.
33	MEM.2	Full memory for event logging Transfer measured data, clear memory, or set automatic overwriting.
34	FAC.SET	Error when reading user configuration from EEPROM Default factory configuration has been set automatically. Repeat device setup. If the message reappears, send the device for repair.
35	FAC.CAL	Loss of factory calibration The converter is operating with reduced accuracy of approx. ±5%. If this message appears, send the device for calibration or upload the factory calibration data.
36	USR.CAL	Error reading user calibration from EEPROM Factory calibration automatically applied. Repeat user calibration. If the message persists, send the device for repair.
50	EEPROM	Serious device error - faulty EEPROM The device is operating in emergency mode, i.e., without the possibility of adjustment and with an error of approx. ±5%. The device must be sent for repair.
56	T/C.CJC	Internal cold junction compensation error The device is operating in an emergency mode, i.e. without the possibility of adjustment and with an error of approx. ±5%. The device must be sent for repair
Setting	YES - NO	Activation or deactivation of individual error messages For each error, the ✓ and ▲ buttons can be used to set the option YES (error is displayed) or NO (error is not displayed). This feature enables quick diagnostics and effective response to error conditions, contributing to reliable operation of the device.



5.6.11 Enabling the device setup wizard restart

☰ INPUTS 5x ⤴ SERVICE ✓ PRESS# 10x ⤴ WIZARD

WIZARD
SERVICE



YES?
WIZARD

Parameter	Setting	Description
Enable Wizard	WIZARD	Re-launching the setup wizard It allows you to launch the initial wizard as and when required. The wizard guides you step by step through the basic device settings. The settings made in the wizard can also be adjusted individually in the menu at a later stage.
YES?	YES?	Enable Wizard After confirming the YES? prompt, the wizard will start when the device is turned on and when you enter the menu.



5. Device settings

5.6.12 Input signal simulation

☰ INPUTS 5x ⤴ SERV IC ✓ PRSSW# 11x ⤴ S IMUL

S IMUL
SERV IC



MIN
S IMUL



MAX
S IMUL



STEP
S IMUL



DURAT
S IMUL



START
S IMUL



STOP
S IMUL

Parameter	Setting	Description
Simulation	S IMUL	Input signal simulation This function allows you to emulate the input signal directly in the device without having to connect an actual external signal. This makes it easy to verify the correct operation of the device as well as the response and functionality of other devices connected to it. This function is ideal for maintenance, service interventions, and configuration verification without having to interfere with the actual operating environment.
MIN	MIN	Start of range for simulation Sets the default value of the simulated signal. Range: -99999...0...999999
MAX	MAX	End of simulation range Sets the end value of the simulated signal. Range: -99999...0...999999
STEP	STEP	Step/change sizes Defines the size of the change in signal value between individual simulation steps Range: -99999...1...999999
DURAT	DURAT	Duration of a step/change Sets the duration of each simulation step in milliseconds. Range: 0...10 000 ms
StART	START	Start of simulation Starts the simulation with preset parameters. YES?
StOP	STOP	Stop of simulation Ends the simulation and restores standard operating mode. YES?



Simulated signal

The type of simulated signal (DC, PM RTD, etc.) depends on its setting in the **INPUT/AN.INP/TYPE** menu.

5.6.13 Displaying information about the device

☰ INPUTS 5x ⤴ SERVICE ⤵ PRESS# 12x ⤴ RBDU

INFO
SERVICE



0M503
TYPE



010404
FW.VERS



313008
SER.NO



12h
RUN.TIM



26
PWR.ONS



428
REL.CYC

Parameter	Setting	Description
Info	INFO	Displays device information This function allows you to view basic information about the device, providing an overview of its status, operating history, and key parameters. For more detailed information and a comprehensive view of the device parameters, we recommend using the OM Link program, which allows for detailed analysis of operating data and diagnostics.
TYPE	TYPE	Device type Displays the device type designation for easy identification.
FW.VERS	FW.VERS	Firmware version Displays the current firmware (FW) version installed on the device. The first four digits clearly identify the valid version of the user manual. The last two digits do not affect this version.
SER.NO	SER.NO	Device serial number Displays the device serial number.
CPU.TMP	CPU.TMP	Temperature inside the device [°C] Displays the current internal temperature of the device, which helps monitor operating conditions and prevent overheating.
VOLTAGE	VOLTAGE	Voltage of the main power supply [V] Displays the current value of the internal power supply section of the device.
CURRENT	CURRENT	Current consumption [mA] Displays the current consumption of the internal power supply section of the device.
RUN.TIM	RUN.TIM	Total running time [Hour meter] Indicates the total operating time of the device in hours, which is useful for maintenance planning and monitoring service life.
PWR.ONS	PWR.ONS	Number of times the device has been powered on Records the total number of times the device has been turned on during its lifetime.
REL.CYC	REL.CYC	Number of relay activations Displays the number of times the most frequently used relay has been activated, allowing you to monitor its wear and prevent possible malfunctions.



6. USER level setting

SETTING USER

Designed for operator's easy access

Menu items are selected by the user as required

Access is not password protected

6.0 Setting items in the „USER“ menu

- The USER menu is intended for users who only need to change selected settings without having access to the complete configuration of the device (e.g., frequent changes of relay setpoint).
- The USER menu settings (item selection) are configured using the OM Link software by checking the box in front of the desired menu item.



Accessing the USER menu

- Enter menu



Selecting a USER menu item (Example)

- Move to next item - down
- Move to next item - up
- Confirm selection and set value



Setting the setpoint for Limit 1 (Example)

-99999...100...999999

- Move to next item - down
- Move to next item - up
- Move to next decade - left
- Confirm selection and continue with settings if desired



Accessing the PRO menu

If the USER menu is active, access the PRO menu as follows:

- Enter the menu
- Move to the last MENU item
After entering the correct password, the device will automatically switch to the PRO menu.

7. Data protocol

The devices can communicate via an RS232 or RS485 serial line using ASCII, Modbus RTU or OM SLAV/MAST format (provided a data communication card is present).

The Baud rate can be set in the device menu. The device address can be set in the device menu in the range 0 ÷ 99. The default setting is ASCII protocol, rate 9600 Baud, address 00.

The type of line used - RS232/RS485 is determined by the communication card, which the device automatically detects and identifies after it had been inserted.

The commands are described in the description available at www.orbitmerret.eu/en/om-403uni#download

Detailed description of communication via serial line

Action	Transmitted data				
Data request (PQ)	#	A	A	<CR>	
Data transmission (Device)	#	A	A	1X	<CR>
Transmission value 1st channel (Device)	#	A	A	1x	<CR>
Transmission value 2nd channel (Device)	#	A	A	2x*	<CR>
Transmission of CJC value (Device)	#	A	A	1q	<CR>
Transmission of status information TT;RR (Device)	#	A	A	S	<CR>
Command confirmation (Device) - OK	!	A	A	<CR>	
Command confirmation (Device) - Bad	?	A	A	<CR>	
HW identification	#	A	A	1Z	<CR>

* this number depends on the number of channels in the connected device

Legend

Symbol	Range	Description
#	35 23 _h	Start of command
A A	0...31	Two characters of the device address sent in ASCII - tens and single digits, e.g. "0.1", "99" universal
<CR>	13 0D _h	Carriage return
D		Data - usually characters „0“... „9“, „.“, „.“; (D) - DP and (.) can extend data
TT		Bit map Tare
RR		Bit map Relay
!	33 21 _h	Positive command confirmation (ok)
?	63 3F _h	Negative confirmation of command (bad)
>	62 3E _h	Start of transmitted data

Bitmap

Bit	Tare	Relay
0	Tare A	Relay 1
1	Tare B	Relay 2
2	Tare C	Relay 3
3	Tare D	Relay 4
4	Tare E	Relay 5
5	Tare F	Relay 6

This device supports communication via open industrial protocols (e.g., Modbus TCP). These protocols do not inherently include their own encryption or access control mechanisms.

The user is responsible for the secure integration of the device into the network environment and is obliged to ensure the necessary cybersecurity measures in accordance with legislation (e.g., NIS2 Directive, upcoming cybersecurity law).

■ Operation in a secure network

The device must be operated exclusively in a separate industrial network, not directly connected to the public internet. Access to the network must be protected by a firewall and monitored.

Network segmentation (separating the technological part from the regular office network) is recommended.

■ Access and authorization

Only authorized and trained personnel may have access to the device.

The device allows password settings, so the default settings must be changed immediately. It is recommended to keep records of access and setting changes.

■ Maintenance and updates

The device does not contain a standard operating system and is therefore not subject to regular updates by the manufacturer.

The user must ensure regular network maintenance, including updates to network components (switches, routers, firewalls). If a firmware update is released, the manufacturer recommends installing it.

■ Communication and protocols

The device communicates using standard industrial protocols (e.g., Modbus TCP).

These protocols are not encrypted or authenticated.

The user is therefore obliged to ensure

- data transmission only within the internal network,
- protection of communication (e.g., VPN tunnel for remote access),
- restriction of access to ports on network devices.

■ User's responsibility

The manufacturer supplies the device as a measuring and control component.

The user is responsible for integrating the device into a secure network environment, setting up security measures, and checking them regularly.

■ Recommendations

Include the device in the internal asset inventory and risk management according to the internal cybersecurity policy. Regularly check logs and network traffic.

Ensure the physical security of the device against unauthorized tampering.

Train operators and maintenance personnel in cybersecurity.

9. Table of characters

In addition to displaying numerical data, the digital panel device also allows you to add user-defined text or units of measurement to the measured value. This feature increases the clarity and comprehensibility of the display.

Display of units

A unit of measurement corresponding to the measured physical parameter can be assigned to the numerical value. The display supports units with a maximum length of 2 characters (for example: V, A, mA, Ω, °C).

Display of additional description

An additional text can be displayed on the secondary display to specify the measured quantity or connected device/sensor in more detail. This text can contain up to 6 characters and can be fully customized for a specific application.

Table of displayable characters

Below is an overview of all characters that can be displayed on the screen when setting units or additional text:

A B C D E F G H I J K L M N O P Q R S T U V W X Y Z
a b c d e f g h i j k l m n o p q r s t u v w x y z
0 1 2 3 4 5 6 7 8 9
° % / \ . Ω [] ^ * u (Space)

Setting special characters in the OM Link SW

- ◻ Alt+0176 (as in degrees)
- ◻ Alt+8486 (03A9) (as in Ohm)

10. Error messages

ERR	Text on display	Error description	Error resolution
	-----	Input disconnected or no signal	Check the input connection.
01	RNG.OVR	Input range exceeded by $\pm 10\%$	Change the input signal value or input settings (range).
02	AD.OVR	AD converter overflow/underflow	Change the input signal value or input settings (range).
03	SENSOR	Sensor wire broken	Check the cable and sensor connection.
04	TC.WIRE	Thermocouple wire broken	Check the cable and sensor connection.
05	LOOP.IN	Input current loop broken	Check the cable and input current loop connection.
10	LOOP.OUT	Output current loop broken	Check the cable and output current loop connection.
20	MATH.FN	Mathematical function error	Change the mathematical function settings.
21	L.INTRB	Linearization table error	Change/add linearization table settings.
31	RTC	RTC error	Set the date and time
32	MEM.1	Data memory is full	Export the recorded logs, clear the memory, or set automatic overwriting.
33	MEM.2	The event log memory is full	Export the recorded logs, clear the memory, or set automatic overwriting.
34	FAC.SET	Error while reading user configuration from EEPROM. Default configuration set automatically	Repeat the device settings. If the message persists, send the device for repair.
35	FAC.CAL	Loss of factory calibration. The device operates with reduced accuracy (approx. $\pm 5\%$)	If this message appears, send the device for calibration or upload the factory calibration data if you had archived them.
36	USR.CAL	Error reading user calibration from EEPROM. Factory calibration automatically applied	Repeat user calibration. If the message reappears, send the device for repair.
50	EEPROM	Serious device error - faulty EEPROM. The device operates in emergency mode, i.e. without the possibility of configuration and with an error of approx. 5%	When this message appears, send the device for repair.

ERR 34-50 errors are displayed continuously, i.e. until they are resolved.

11. Technical data

VSTUP

No. of inputs	1, The range is adjustable in the instrument menu
T Range	1..2 mV/V 2..4 mV/V 4..8 mV/V 8..16 mV/V
Sensor power supply	10 VDC, load ≥ 80 Ω 5 V on request
Connection	4- or 6-wire Connection settings via DIP switch
Division size	0.001 / 0.002 / 0.005 / 0.01 / 0.02 / 0.05 / 0.1 / 0.2 / 0.5 / 1 / 2 / 5 / 10 / 20 / 50 / 100
Zero tracking	the zero is automatically maintained within 4 % of the measuring range, provided that the correction does not exceed 0.5 scale division/second
Automatic scale zeroing	if a negative value remains steady on the display for more than 5 seconds (with the Tare function active), automatic taring occurs

CONTROL INPUTS AND OUTPUTS

No. of inputs	3, isolated, per contact, PNP/NPN, < 30 V
Function	No function assigned Activation of Tare Reset of Tare Reset of Min./Max. and PEAK values Tare activation (<1 s) + Zero tare (>1 s) Activation of Tech-In for Offset Open relay/OC (Type LATCH) Controlling of cumulative measurement Min/Max and PEAK value Measurement paused Take a one-off measurement Value of minimum/maximum/MAX-MIN/Average* Device buttons blocked Data recording Delete memory Show value of all Channels and Brutto
No. of output	1, isolated, open collector 30 V/100 mA
Function Ready	Active when the device reports no error messages

*The value is calculated from the period since the previous activation of the external input

PROJECTION

Primary display	-99999...999999, three-color alphanumeric LED, 6 digits 11-segment, red / green / orange, digit height 14 mm
Secondary display	-99999...999999, single-color alphanumeric LED, 6 digits, 11-segment, green, digit height 7 mm
Info display	0...99, single-color alphanumeric LED, 2 digits, 11-segment, orange, digit height 7 mm
Bar graph	17 single-color LEDs, horizontal column, orange
Signal LEDs	20 single-color LEDs indicating device functions and status (red, yellow, orange)
Decimal point	adjustable, floating or exponential display
Description	displayed on the secondary display or on the last two characters of the primary display
Brightness	adjustable or automatic

DEVICE SPECIFICATIONS

TC	25 ppm/°C
Accuracy	±0.025 % of range ±0.03 % of range Accuracy specified at 20 meas./s, display 9999 2 mV/V (5 V)
Rate	5 / 10 / 20 / 50 / 100 / 400 / 1200 meas./second
IIR filter	maintains hum suppression (50/60 Hz) greater than 45 dB (≈180× reduction of interference amplitude) For measurement speeds >100 measurements/s
Overload	10x (t < 30 ms), 2x
Controls	5 capacitive touch buttons with RGB backlighting and haptic feedback
Funkce	Teach-in, offset, tare, min/max value, peak value, mathematical functions, delayed start, simulation, error and event logging
Timer	time and daily operational restrictions of the device, functions, and its peripherals (data recording, relays, ...)
Digital filters	exponential / floating / arithmetic average, rounding
Mathematical functions	polynomial / inverse polynomial / logarithm / exponential / power / root
Linearization	linear interpolation in 300 points setup only via OM Link
Time	accuracy < 1 minute/year
Data recording	< 100 000 entries Long-term time-date-measured value One-off measurement (Shot) Fast < 400 measurements/s
OM Link	company communication interface for operation, setting and update of instruments (BT, USB-C)
Time	accuracy < 1 minute/year
Watch-dog	reset after 500 ms
Calibration	at 25°C and 40 % RH.

RELAY / OPEN COLLECTOR OUTPUT

No. of outputs	up to 6
Type	digital, menu adjustable
Mode	RISE active above set value FALL active below set value WINDOW active in the set window / band BATCH active in set periods
Function Relays/OC	SW. ON is closed in active mode SW. OFF is open in active mode PULSE switches on once in active mode LATCH in active mode the output is switched permanently, disconnection is blocked (IEC EN 61496) disconnection is performed by ext. input
Limits	-99999...999999
Hysteresis	0...999999
Delay / Duration	0...999.9 s
Outputs	2 - 4x relay with switching contact (Form C) (250 VAC/50 VDC, 3 A)* 3 - 6x relay with switch-on contact (Form A) (250 VAC/30 VDC, 3 A)* 3 - 6x open collector (30 VDC/100 mA)
Relays	1/8 HP 277 VAC, 1/10 HP 125 V, Pilot Duty D300

* values apply for resistance load

11. Technical data

ANALOG OUTPUTS

No. of outputs	1 or 2																								
Type	isolated, adjustable with 16-bit DAC, output type and range is selectable																								
TC	15 ppm/°C																								
Accuracy	±0.02% of FS ±0.03% of FS ±0.06% of FS																								
Rate	response to change of value < 160 µs																								
Range	<table border="0"> <tr> <td><i>Range</i></td> <td><i>Error indication</i></td> <td></td> </tr> <tr> <td>0...2 V</td> <td>~2.2 V</td> <td>resistive load ≥ 1 kΩ</td> </tr> <tr> <td>0...5 V</td> <td>~5.5 V</td> <td>resistive load ≥ 1 kΩ</td> </tr> <tr> <td>0...10 V</td> <td>~11.0 V</td> <td>resistive load ≥ 1 kΩ</td> </tr> <tr> <td>±10 V</td> <td>~11.0 V</td> <td>resistive load ≥ 1 kΩ</td> </tr> <tr> <td>0...5 mA</td> <td>~5.5 mA</td> <td>compensation < 600 Ω/12 V</td> </tr> <tr> <td>0...20 mA</td> <td>~22.0 mA</td> <td>compensation < 600 Ω/12 V</td> </tr> <tr> <td>4...20 mA</td> <td>~3.2 mA</td> <td>compensation < 600 Ω/12 V</td> </tr> </table> <p>Indication of broken current loop</p>	<i>Range</i>	<i>Error indication</i>		0...2 V	~2.2 V	resistive load ≥ 1 kΩ	0...5 V	~5.5 V	resistive load ≥ 1 kΩ	0...10 V	~11.0 V	resistive load ≥ 1 kΩ	±10 V	~11.0 V	resistive load ≥ 1 kΩ	0...5 mA	~5.5 mA	compensation < 600 Ω/12 V	0...20 mA	~22.0 mA	compensation < 600 Ω/12 V	4...20 mA	~3.2 mA	compensation < 600 Ω/12 V
<i>Range</i>	<i>Error indication</i>																								
0...2 V	~2.2 V	resistive load ≥ 1 kΩ																							
0...5 V	~5.5 V	resistive load ≥ 1 kΩ																							
0...10 V	~11.0 V	resistive load ≥ 1 kΩ																							
±10 V	~11.0 V	resistive load ≥ 1 kΩ																							
0...5 mA	~5.5 mA	compensation < 600 Ω/12 V																							
0...20 mA	~22.0 mA	compensation < 600 Ω/12 V																							
4...20 mA	~3.2 mA	compensation < 600 Ω/12 V																							

DATA OUTPUT

No. of outputs	1						
Protocol	ASCII, Modbus RTU, Modbus TCP/IP, PROFINET						
Rate	600...921 600 Baud 10 Mbit/s, 100 Mbit/s (Modbus TCP/IP, ProfiNET)						
Data format	<table border="0"> <tr> <td>Format</td> <td>8 bits + parity + stop bit</td> </tr> <tr> <td>Parity</td> <td>none / event / odd</td> </tr> <tr> <td>Stop bits</td> <td>1/1.5 / 2</td> </tr> </table>	Format	8 bits + parity + stop bit	Parity	none / event / odd	Stop bits	1/1.5 / 2
Format	8 bits + parity + stop bit						
Parity	none / event / odd						
Stop bits	1/1.5 / 2						
Addressing	1...99 instruments ASCII 1...247 instruments Modbus						
Line termination	with internal resistor 120 Ω <i>DIP switch on the last device</i>						

POWER SUPPLY

Range	10...30 V AC/DC, PF ≥ 0.4, I _{isp} < 40 A / 1 ms, isolated 80...250 V AC/DC, PF ≥ 0.4, I _{isp} < 40 A / 1 ms, isolated <i>Protection by fuse inside the device</i>
Consumption	< 9.4 W / 9.2 VA

MECHANICAL PROPERTIES

Material	Noryl GFN2 SE1, non-flammable UL 94 V-1, black
Dimensions	96 x 48 x 120 mm (v x h x d)
Panel cut-out	90 x 45.5 mm (w x h)

OPERATING CONDITIONS

Connection	connector terminal blocks, section < 1.5 / 2.5 mm ²
Stabilization period	5 minutes after power on
Working temperat.	-20°...60°C
Storage temperat.	-20°...85°C
Operating humidity	< 95% RH, non-condensing
Protection	IP65, front panel only
Construction	safety class I
EI. safety	EN 61010-1, A2
Dielectric strength	4 kVAC per 1 min test between supply and input 4 kVAC per 1 min test between supply and data/ analog output 4 kVAC per 1 min test between input and relay output 2.5 kVAC per 1 min test between input and data/ analog output
Insulation resist.*	for pollution degree II, measurement category III device power supply > 670 V (ZI), 300 V (DI) input, output > 300 V (ZI), 150 V (DI)
EMC	EN IEC 61326-1:2021, Industrial area EN IEC 62003:2021, Nuclear facilities
RoHS	EN IEC 63000:2018
Seismic capability	EN IEC/IEEE 60980-344 ed. 1.0:2020, par. 6, 9
Mechanical resist- ance	EN 60068-2-6 ed. 2:2008

* PI - Primary insulation, DI - Double insulation

12. Device dimensions and installation

Front view

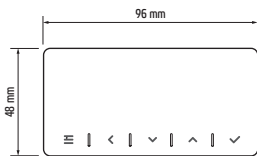

Panel cut-out

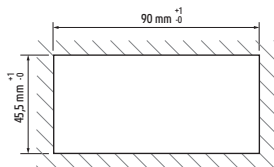

Side view

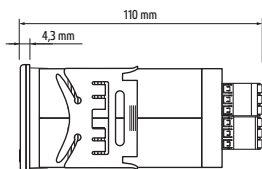

Panel thickness: 0,5...12 mm

DEVICE INSTALLATION

1. Insert the meter into the opening in the panel
2. Place both sliding clips on the housing, one on each side
3. Press the sliding clips firmly against the panel to ensure a tight seal

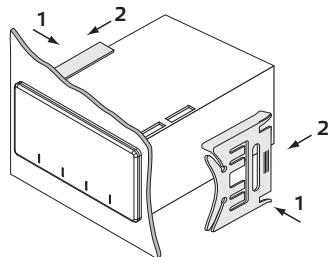

REMOVING THE DEVICE

1. Insert a screwdriver under the edge of the clip
2. Turn the screwdriver and remove the clip
3. Remove the device from the panel

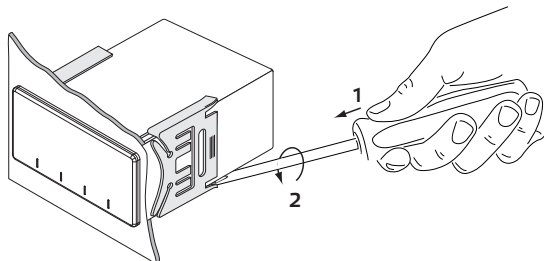

13. Warranty sheet

Product **OM 503T**
Type
Serial No.
Date of sale

This device is covered by a warranty period of 60 months from the date of sale to the 1st customer. Defects arising during this period due to manufacturing errors or material defects will be repaired free of charge.

The quality, operation, and performance of the device are covered by warranty if the device has been connected and used strictly in accordance with the instructions.

The warranty does not cover defects caused by:

- mechanical damage
- transport
- interference by unauthorized persons, including the user
- force majeure
- other unprofessional interventions

Warranty and post-warranty repairs are performed by the manufacturer, unless otherwise specified.

Stamp, signature

Note

EC declaration of conformity

Company **ORBIT MERRET, spol. s r.o.**
Klánova 81/141, 142 00 Praha 4, Czech Republic VAT registration No.: CZ00551309

Manufacturer **ORBIT MERRET, spol. s r.o.**
Vodňanská 675/30, 198 00 Praha 9, Czech Republic

declare under our sole responsibility that the product described below complies with the requirements of technical regulations, that the product is safe under the conditions of use specified by us, and that we have taken all measures to ensure that all products of the type described below placed on the market comply with the technical documentation and the requirements of the relevant Czech government regulation.

Product Panel measuring device
Type **OM 503**
Version DC, PM, DU, T, LVDT

The subject of the declaration described above complies with the harmonized legislation of the European Union

Low-voltage electrical equipment - Directive No. 2014/35/EU
Electromagnetic compatibility - Directive No. 2014/30/EU
Restriction of the use of certain hazardous substances in electrical and electronic equipment - Directive No. 2011/65/EU, 2015/863/EU

The product properties comply with the harmonized standard

EN 61010-1:2011 Electrical safety
EN 61326-1:2022 Electrical measuring, control and laboratory equipment - EMC requirements
EN IEC 62003:2021 Nuclear facilities – EMC requirements for electrical equipment important for safety
EN IEC 63000:2018 RoHS
EN IEC/IEEE 60980-344 Seismic performance for nuclear facilities
EN 60068-2-6 ed.2:2008 Mechanical resistance – vibration

The product bears the CE marking, issued in 2025

The protocols of the below listed authorized and accredited organizations serve as proof.

EMC ABEGU, a.s., Laboratory L 1184, protocol No.: P/25/01/77 of 21.08.2025
Seismic suitability VTÚ, s.p., Laboratory L 1103, protocol No.:194200-205/2025 of 29.08.2025
Mechanical resistance

Place and date of issue: Prague, September 1, 2025

Publisher of the declaration: Miroslav Hackl, company executive



ORBIT MERRET, spol. s r. o.

Vodňanská 675/30
198 00 Praha 9
Czech Republic

tel.: +420 281 040 200
fax.: +420 281 040 299
info@orbitmerret.eu
www.orbitmerret.eu

