



OM 402UNI

**4 DIGIT PROGRAMMABLE
UNIVERSAL INSTRUMENT**

DC VOLTMETER/AMMETER

PROCESS MONITOR

OHMMETER

THERMOMETER FOR PT 100/500/1 000

THERMOMETER FOR NI 1 000

THERMOMETER FOR THERMOCOUPLES

DISPLAYS FOR LIN. POTENTIOMETERS

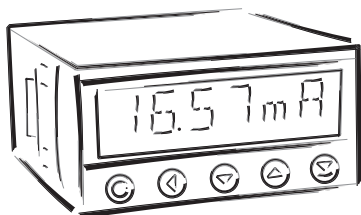

SAFETY INSTRUCTIONS

Please, read the enclosed safety instructions carefully and observe them!
These instruments should be safeguarded by isolated or common fuses (breakers)!
For safety information the EN 61 010-1 + A2 standard must be observed.
This instrument is not explosion-safe!

TECHNICAL DATA

Measuring instruments of the OM 402 series conform to the European regulation 89/336/EEG and the Ordinance 168/1997 Coll.

The instruments are up to the following European and Czech standards:

EN 55 022, class B

EN 61000-4-2, -4, -5, -6, -8, -9, -10, -11

The instruments are applicable for unlimited use in agricultural and industrial areas.

CONNECTION

Supply of energy from the main line has to be isolated from the measuring leads.



ORBIT MERRET, spol. s r.o.

Vodnanská 675/30

198 00 Prague 9

Czech Republic

Tel: +420 - 281 040 200

Fax: +420 - 281 040 299

e-mail: orbit@merret.cz

www.orbit.merret.cz



1.	Contents	3
2.	Instrument description	4
3.	Instrument connection	6
4.	Instrument setting	8
	Symbols used in the instructions	10
	Setting the DP and the (-) sign	10
	Control keys function	11
	Setting/permitting items into "USER" menu	11
5.	Setting "LIGHT" menu	12
5.0	Description "LIGHT" menu	12
	Setting input - Type "DC"	16
	Setting input - Type "PM"	18
	Setting input - Type "DU"	20
	Setting input - Type "OHM"	22
	Setting input - Type "RTD - Pt"	24
	Setting input - Type "RTD - Ni"	26
	Setting input - Type "T/C"	28
	Setting Limits	30
	Setting analog output	32
	Selection of programming menu „LIGHT"/„PROFI"	34
	Restoration of manufacture setting	34
	Calibration - input range (DU)	35
	Selection of instrument menu language version	36
	Setting new access password	36
	Instrument identification	37
6.	Setting "PROFI" menu	38
6.0	Description of "PROFI" menu	38
6.1	"PROFI" menu - INPUT	
6.1.1	Resetting internal values	40
6.1.2	Setting measuring type, range, mode, rate, ...	43
6.1.3	Setting the Real Time	47
6.1.4	External input function selection	47
6.1.5	Optional accessory functions of the keys	48
6.2	"PROFI" menu - CHANNEL	
6.2.1	Setting measuring parameters (projection, filters, decimal point, description)	52
6.2.2	Setting mathematic functions	56
6.2.3	Selection of evaluation of min/max. value	58
6.3	"PROFI" menu - OUTPUT	
6.3.1	Setting data logging	60
6.3.2	Setting Limits	62
6.3.3	Setting data output	64
6.3.4	Setting analog output	65
6.3.5	Selection of display projection	67
6.4	"PROFI" menu - SERVICE	
6.4.1	Selection of programming menu „LIGHT"/„PROFI"	68
6.4.2	Restoration manufacture setting	69
6.4.3	Calibration - input range (DU)	69
6.4.4	Selection of instrument menu language version	70
6.4.5	Setting new access password	70
6.4.6	Instrument identification	70
7.	Setting items into "USER" menu	72
7.0	Configuration "USER" menu	72
8.	Method of measuring of the cold junction	74
9.	Data protocol	75
10.	Error statements	76
12.	Table of symbols	77
12.	Technical data	78
13.	Instrument dimensions and installation	80
14.	Certificate of guarantee	81
	Declaration of conformity	84

2.1 Description

The OM 402 model series are 4 digit panel programmable instruments designed for maximum efficiency and user comfort while maintaining their favourable price. Two models are available: UNI and PWR.

Type OM 402UNI is a multifunction instrument with the option of configuration for 7 various input options, easily configurable in the instrument menu. By further options of input modules it is feasible to measure larger ranges of DC voltage and current or increase the number of inputs up to 4 (applies for PM).

The instrument is based on an 8-bit microcontroller with a multichannel 24-bit sigma-delta converter, which secures high accuracy, stability and easy operation of the instrument.

The OM 402 is a multifunction instrument available in following types and ranges

type UNI

DC:	0...60/150/300/1200 mV
PM:	0...5 mA/0...20 mA/4...20 mA/±2 V/±5 V/±10 V/±40 V
OHM:	0...100 Ω/0...1 kΩ/0...10 kΩ/0...100 kΩ
RTD-Pr:	Pt 100/Pt 500/Pt 1000
RTD-Ni:	Ni 1 000/Ni 10 000
T/C:	J/K/T/E/B/S/R/N
DU:	Linear potentiometer (min. 500 Ω)

type UNI, option A

DC:	0...1 A/0...5 A/±30 V/±120 V/±500 V
------------	-------------------------------------

type UNI, option B (expansion by 3 more inputs)

PM:	3x 0...5 mA/0...20 mA/4...20 mA/±2 V/±5 V/±10 V/±40 V
------------	---

PROGRAMMABLE PROJECTION

Selection:	of type of input and measuring range
Measuring range:	adjustable as fixed or with automatic change
Setting:	manual, optional projection on the display may be set in the menu for both limit values of the input signal, e.g. input 0...20 mA > 0...850,0
Projection:	-9999...9999 (-99999...999999)

COMPENSATION

of conduct:	in the menu it is possible to perform compensation for 2-wire connection
of conduct in probe:	internal connection (conduct resistance in measuring head)
of CJC (T/C):	manual or automatic, in the menu it is possible to perform selection of the type of thermocouple and compensation of cold junctions, which is adjustable or automatic (temperature at the brackets)

LINEARIZATION

Linearization:*	by linear interpolation in 50 points (solely via OM Link)
-----------------	---

DIGITAL FILTERS

Exponen.average:	from 2...100 measurements
Rounding:	setting the projection step for display

MATHEMATIC FUCTIONS

Min./max. value:	registration of min./max. value reached during measurement
Tare:	designed to reset display upon non-zero input signal
Peak value:	the display shows only max. or min. value
Mat. operations:	polynome, 1/x, logarithm, exponential, power, root, sin x

* only for types DC, PM, DU

EXTERNAL CONTROL

Lock:	control keys blocking
Hold:	display/instrument blocking
Tare:	tare activation/resetting tare to zero
Resetting MM:	resetting min/max value
Memory:	data storage into instrument memory

2.2 Operation

The instrument is set and controlled by five control keys located on the front panel. All programmable settings of the instrument are performed in three adjusting modes:

LIGHT	Simple programming menu - contains solely items necessary for instrument setting and is protected by optional number code
PROFI	Complete programming menu - contains complete instrument menu and is protected by optional number code
USER	User programming menu - may contain arbitrary items selected from the programming menu (LIGHT/PROFI), which determine the right (see or change) - access without password

All programmable parameters are stored in the EEPROM memory (they hold even after the instrument is switched off).



Complete instrument operation and setting may be performed via OM Link communication interface, which is a standard equipment of all instruments.

The operation program is freely accessible (www.orbit.merret.cz) and the only requirement is the purchase of OML cable to connect the instrument to PC. It is manufactured in version RS 232 and USB and is compatible with all ORBIT MERRET instruments. Another option for connection is with the aid of data output RS 232 or RS 485 (without the need of the OML cable).

The program OM LINK in „Basic“ version will enable you to connect one instrument with the option of visualization and archiving in PC. The OM Link „Standard“ version has no limitation of the number of instruments connected.

2.3 Options

Excitation is suitable for supplying power to sensors and transmitters. It has a galvanic separation.

Comparators are assigned to monitor one, two, three or four limit values with relay output. The user may select limits regime: LIMIT/DOSING/FROM-TO. The limits have adjustable hysteresis within the full range of the display as well as selectable delay of the switch-on in the range of 0...99,9 s. Reaching the preset limits is signalled by LED and simultaneously by the switch-on of the relevant relay.

Data outputs are for their rate and accuracy suitable for transmission of the measured data for further projection or directly into the control systems. We offer an isolated RS232 and RS485 with the ASCII or DIN MessBus protocol.

Analog outputs will find their place in applications where further evaluating or processing of measured data is required in external devices. We offer universal analog output with the option of selection of the type of output - voltage/current. The value of analog output corresponds with the displayed data and its type and range are selectable in Menu.

Measured data record is an internal time control of data collection. It is suitable where it is necessary to register measured values. Two modes may be used. FAST is designed for fast storage (40 records/s) of all measured values up to 8 000 records. Second mode is RTC, where data record is governed by Real Time with data storage in a selected time segment and cycle. Up to 250 000 values may be stored in the instrument memory. Data transmission into PC via serial interface RS232/485 and OM Link.

The instrument supply leads should not be in proximity of the incoming low-potential signals.

Contactors, motors with larger input power should not be in proximity of the instrument.

The leads into the instrument input (measured quantity) should be in sufficient distance from all power leads and appliances. Provided this cannot be secured it is necessary to use shielded leads with connection to ground (bracket E).

The instruments are tested in compliance with standards for use in industrial area, yet we recommend to abide by the above mentioned principles.

MEASURING RANGES

Type	Input I	Input U
DC	0...60/150/300/1 200 mV	
PM	0...5/20 mA/4...20 mA	$\pm 2/\pm 5/\pm 10/\pm 40$ V
OHM	0...0,1/1/10/100 k Ω	
RTD-Pt	Pt 100/Pt 500/ Pt 1 000	
RTD-Ni	Ni 1 000/10 000	
T/C	J/K/T/E/B/S/R/N	
DU	Linear potentiometer (min. 500 Ω)	

OPTION "A"

Type	Input I	Input U
DC	0...1/5 A	$\pm 30/120/500$ V

OPTION "B"

Type	Input 2, 3, 4/1	Input 2, 3, 4/U
PM	0...5/20 mA/4...20 mA	$\pm 2/\pm 5/\pm 10/\pm 40$ V

Setting
PROFI*profi*

- ▶ For expert users
- ▶ Complete instrument menu
- ▶ Access is password protected
- ▶ Possibility to arrange items of the „User“ menu
- ▶ Tree menu structure

Setting
LIGHT*light*

- ▶ For trained users
- ▶ Only items necessary for instrument setting
- ▶ Access is password protected
- ▶ Possibility to arrange items of the „User“ menu
- ▶ Linear menu structure

Setting
USER*profi light**user*

- ▶ For user operation
- ▶ Menu items are set by the user (Profi/Light) as per request
- ▶ Access is not password protected
- ▶ Optional menu structure either tree (PROFI) or linear (LIGHT)

4.1 Setting

The instrument is set and controlled by five control keys located on the front panel. All programmable settings of the instrument are performed in three adjusting modes:

- LIGHT** Simple programming menu
- contains solely items necessary for instrument setting and is protected by optional number code
- PROFI** Complete programming menu
- contains complete instrument menu and is protected by optional number code
- USER** User programming menu
- may contain arbitrary items selected from the programming menu (LIGHT/PROFI), which determine the right (see or change)
- acces without password

All programmable parameters are stored in the EEPROM memory (they hold even after the instrument is switched off).

Complete instrument operation and setting may be performed via OM Link communication interface, which is a standard equipment of all instruments.

The operation program is freely accessible (www.orbit.merret.cz) and the only requirement is the purchase of OML cable to connect the instrument to PC. It is manufactured in version RS 232 and USB and is compatible with all ORBIT MERRET instruments.

Another option for connection is with the aid of data output RS 232 or RS 485 (without the need of the OML cable).

Scheme of processing the measured signal

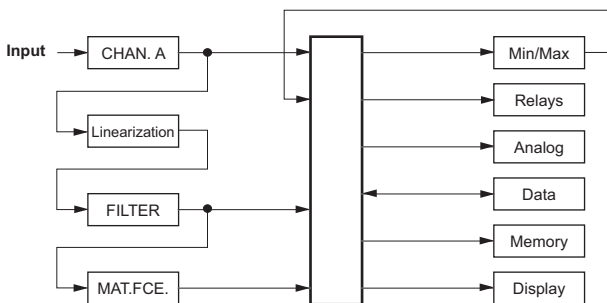

Setting and controlling the instrument is performed by means of 5 control keys located on the front panel. With the aid of these keys it is possible to browse through the operation menu and to select and set required values.

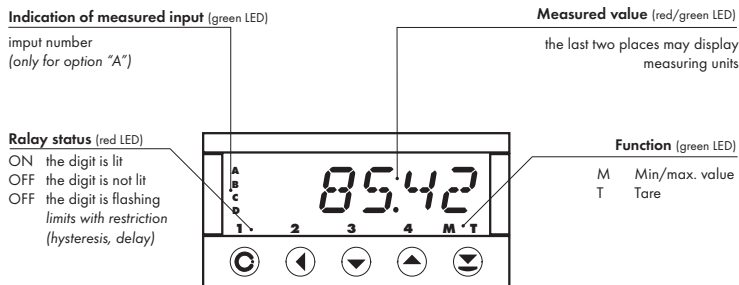

Symbols used in the instructions

DC **PM**
DU **OHM** **RTD** **T/C** Indicates the setting for given type of instrument

DEF values preset from manufacture

symbol indicates a flashing light (symbol)

inverted triangle indicates the item that can be placed in USER menu

broken line indicates a dynamic item, i.e. it is displayed only in particular selection/version

after pressing the key the set value will not be stored

after pressing the key the set value will be stored

30 continues on page 30

Setting the decimal point and the minus sign

DECIMAL POINT

Its selection in the menu, upon modification of the number to be adjusted it is performed by the control key with transition beyond the highest decade, when the decimal point starts flashing. Positioning is performed by .

THE MINUS SIGN

Setting the minus sign is performed by the key on higher decade. When editing the item subtraction must be made from the current number (e.g.: 013 > , on class 100 > -87)

Control keys functions

Key	Measurement	Menu	Setting numbers/selection
	access into USER menu	exit menu	quit editing
	programmable key function	back to previous level	move to higher decade
	programmable key function	move to previous item	move down
	programmable key function	move to next item	move up
	programmable key function	confirm selection	confirm setting/selection
			numeric value is set to zero
	access into LIGHT/PROFI menu		
	direct access into PROF1 menu		
		configuration of an item for "USER" menu	
		determine the sequence of items in "USER - LIGHT" menu	

Setting items into „USER“ menu

- in **LIGHT** or **PROFI** menu
- no items permitted in **USER** menu from manufacture
- on items marked by inverted triangle

Legend is flashing - current setting is displayed



- item will not be displayed in USER menu
- item will be displayed in USER menu with the option of setting
- item will be solely displayed in USER menu

5.0

Setting "LIGHT"

LIGHT

Simple programming menu

- contains only items necessary for instrument setting and is protected by optional number code

SETTING
LIGHT

light

- For capable users
- Only items necessary for instrument setting
- Access is password protected
- Possibility to arrange items of the „User“ menu
- Linear menu structure

Preset from manufacture

Password	"0"
Menu	LIGHT
USER menu	off
Setting the items	DEF

142.8



PASSW

0

Access password



Upon delay exceeding 60 s the programming mode is automatically discontinued and the instrument itself restores the measuring mode

TYPE

1C

MODE

60 mP

Selecting input and range

RTD OHM

CONNECT

2-WIRE

FORM.A

00000.0

Selecting projection and connection

T/C

CONNECT

EXT. ITC

CUCTEM

99

FORM.A

00000.0

DC

PM

OHM

DU

MIN.A

0.0

MAX.A

100.0

FORM.A

00000.0

LIM.L1

200

LIM.L2

400

Option - comparator

LIM.L3

600

LIM.L4

800

Option - Analog output

Typ.AO

I 20

MIN.AO

0

MAX.AO

100

Menu type

MENU

LIGHT

Return to manufacture setting

RESTOR

YES

Calibration - only for "DU"

DU

C.MIN

YES

C.MAX

YES

Language selection

LANG

ENGL

New password

N.PASS

0

Identification

IDENT

YES

01 402...

142.8

Return to measuring mode

1428



PASSW.

0

Entering access password
for access into the menu

PASSW. Access into instrument menu DC PM DU OHM RTD T/C

PAS = 0

- access into menu is unrestricted, after releasing keys you automatically move to first item of the menu

PAS > 0

- access into menu is protected by number code

Set "Password" = 42 Example

01 02 03 04 05 06

32 42 T:PE

T:PE

DC PM OHM RTD - Pt RTD - Ni TC

DU

T:PE Selection of the type of instrument

- primary selection of the type of instrument
- performs default setting **DEF** of values from manufacture, incl. calibration

TYPE	Menu	Type of instrument
	DC	DC voltmeter
	PM	Process monitor
	OHM	Ohmmeter
	RTD-Pt	Thermometer for sensors Pt
	RTD-Ni	Thermometer for sensors Ni
	TC	Thermometer for thermocouples
	DU	Display for lin. potentiometer

Type "PM" Example

DC PM T:PE

Type „DC“	16
Type "PM"	18
Type "DU"	20
Type "OHM"	22
Type "RTD-Pt"	24
Type "RTD-Ni"	26
Type "T/C"	28

Type "DC"



110: E Selection of the instrument measuring range

DEF = 60 mV

MODE	Menu	Measuring range
	60 mV	±60 mV
	150 mV	±150 mV
	300 mV	±300 mV
	1200mV	±1,2 V

Range ±150 mV Example

60 mV | 150 mV | MIN R



110: R Setting display projection for minimum value of input signal

- range of the setting is -99999...999999

- position of the DP does not affect display projection
- the DP is automatically shifted after the value is confirmed

DEF = 0

Projection for 0 mV > Min = 0 Example

0 | 1 | 2 | 3 | 4 | 5 | 6 | 7 | 8 | 9 | MIN R



11R::A Setting display projection for maximum value of input signal

- position of the DP does not affect display projection
- the DP is automatically shifted after the value is confirmed

DEF = 100

Projection for 150 mV > Max = 3500 Example

100	100	100	200	300	400	
500	0500	1500	2500	3500		FORM.A

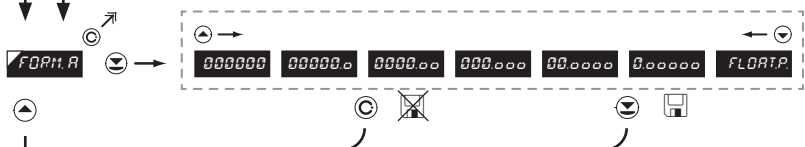

FORM.A Setting projection of the decimal point

DEF = 0000.00

- positioning of the DP is set here in the measuring mode

Projection of DP on display > 00000.0 Example

0000.00	00000.0	MENU
---------	---------	------

*subsequent item on the menu depends on instrument equipment



Type "PM"

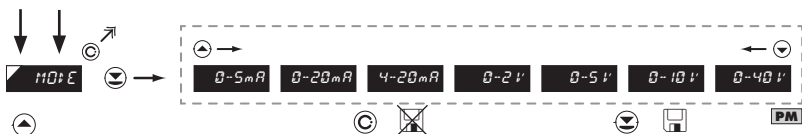

H0: E Selection of the instrument measuring range

DEF = 4 - 20 mA

MODE	Menu	Range
	0-5mA	0...5 mA
	0-20mA	0...20 mA
	4-20mA	4...20 mA
	0-2 V	±2 V
	0-5 V	±5 V
	0-10 V	±10 V
	0-40 V	±40 V

Range 0...20 mA Example

4-20 mA 0-20 mA MIN R



MIN R Setting display projection for minimum value of input signal

- range of the setting is -99999...999999

DEF = 0

Projection for 0 mA > Min = -25 Example

0.5 -1 -5 -10 -25 MIN R

- position of the DP does not affect display projection
- the DP is automatically shifted after the value is confirmed



MR: R Setting display projection for maximum value of input signal

- position of the DP does not affect display projection
- the DP is automatically shifted after the value is confirmed

DEF = 100

Projection for 20 mA > Max = 2500 Example

100	100	100	200	300	400
500	0500	1500	2500	FORM: R	

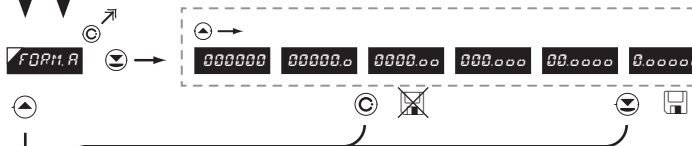

FORM: R Setting projection of the decimal point

DEF = 0000.00

- positioning of the DP is set here in the measuring mode

Projection of DP on display > 00000.0 Example

0000.00	00000.0	11E+11
---------	---------	--------

* subsequent item on the menu depends on instrument equipment

Type "DU"



MIN Setting display projection for minimum value of input signal

- range of the setting is -99999...999999

- position of the DP does not affect display projection
- the DP is automatically shifted after the value is confirmed

DEF = 0

Projection for the beginning > Min = 0

Example



MAX R Setting display projection for maximum value of input signal

- range of the setting is -99999...999999

- position of the DP does not affect display projection
- the DP is automatically shifted after the value is confirmed

DEF = 100

Projection for the end > Max = 5000

Example



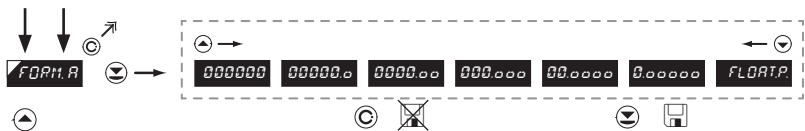

FORM.A Setting projection of the decimal point **DEF** = 0000.00

- positioning of the DP is set here in the measuring mode

Projection of DP on display > 0000.00 Example

0000.00 * subsequent item on the menu depends on instrument equipment

30

Calibration of the beginning and the end of range of linear potentiometer is on page 35



Type "RTD-Pt"



MOD: E Selection of instrument measuring range

DEF = Pt 100

MODE	Menu	Measuring range
	EU-100	Pt 100 (3 850 ppm/°C)
	EU-500	Pt 500 (3 850 ppm/°C)
	EU-1k0	Pt 1000 (3 850 ppm/°C)
	US-100	Pt 100 (3 920 ppm/°C)

Range - Pt 1 000 > MOD = EU-1k0 Example

EU-100 ◀ EU-500 ▶ EU-1k0 ⏻ **CONNECT**



CONNECT Selection of the type of sensor connection

DEF = 2-WIRE

CONNECT.	Menu	Connection
	2-WIRE	2-wire
	3-WIRE	3-wire
	4-WIRE	4-wire

Type of connection - 3 wire > CONNEC = 3-WIRE Example

2-WIRE ▶ 3-WIRE ⏻ **CONNECT**



FORM.A Setting projection of the decimal point **DEF** = 00000.0

- positioning of the DP is set here in the measuring mode

Projection of DP on display > 000000 Example

00000.0 000000 MENU * subsequent item on the menu depends on instrument equipment

30

RTD - Pt RTD - Pt RTD - Pt RTD - Pt RTD - Pt RTD - Pt RTD - Pt RTD - Pt RTD - Pt

Type "RTD-Ni"



MOD: E Selection of instrument measuring range

DEF = Ni 1 000 - 5 000 ppm/°C

MODE	Menu	Measuring range
	5.0-1k	Ni 1 000 (5 000 ppm/°C)
	6.2-1k	Ni 1 000 (6 180 ppm/°C)
	5.0-10k	Ni 10 000 (5 000 ppm/°C)
	6.2-10k	Ni 10 000 (6 180 ppm/°C)

Range - Pt 1 000 > MOD = EU-1k0 Example

EU-100 ◀ EU-500 ◀ EU-1+0 ▶ **CONNECT**



CONNECT Selection of the type of sensor connection

DEF = 2-WIRE

PRIPOL	Menu	Connection
	2-WIRE	2-wire
	3-WIRE	3-wire
	4-WIRE	4-wire

Type of connection - 3 wire > CONNEC = 3-WIRE Example

2-WIRE ◀ 3-WIRE ▶ **FDPH: R**



FORM.A Setting projection of the decimal point **DEF** = 00000.0

- positioning of the DP is set here in the measuring mode

Projection of DP on display > 000000 *Example*

00000.0 000000 MENU *subsequent item on the menu depends on instrument equipment

RTD-Ni RTD-Ni RTD-Ni RTD-Ni RTD-Ni RTD-Ni RTD-Ni RTD-Ni RTD-Ni



LIM L.1 Setting boundary for limit 1

- range of the setting is -99999...999999
- default "Hysteresis"=0 "Delay"=0

DEF = 20

Setting limit 1 > L1 = 32 Example

20	21	22	23	24	25	26	27	28	29	30	31	32	33	34	35	36	37	38	39	40	41	42	43	44	45	46	47	48	49	50	51	52	53	54	55	56	57	58	59	60	61	62	63	64	65	66	67	68	69	70	71	72	73	74	75	76	77	78	79	80	81	82	83	84	85	86	87	88	89	90	91	92	93	94	95	96	97	98	99	MEMU
----	----	----	----	----	----	----	----	----	----	----	----	----	----	----	----	----	----	----	----	----	----	----	----	----	----	----	----	----	----	----	----	----	----	----	----	----	----	----	----	----	----	----	----	----	----	----	----	----	----	----	----	----	----	----	----	----	----	----	----	----	----	----	----	----	----	----	----	----	----	----	----	----	----	----	----	----	----	----	----	------



LIM L.2 Setting boundary for limit 2

- range of the setting is -99999...999999
- default "Hysteresis"=0 "Delay"=0

DEF = 40

Setting limit 2 > L2 = 53.1 Example

40	41	42	43	44	45	46	47	48	49	50	51	52	53	54	55	56	57	58	59	60	61	62	63	64	65	66	67	68	69	70	71	72	73	74	75	76	77	78	79	80	81	82	83	84	85	86	87	88	89	90	91	92	93	94	95	96	97	98	99	MEMU
----	----	----	----	----	----	----	----	----	----	----	----	----	----	----	----	----	----	----	----	----	----	----	----	----	----	----	----	----	----	----	----	----	----	----	----	----	----	----	----	----	----	----	----	----	----	----	----	----	----	----	----	----	----	----	----	----	----	----	----	------

* subsequent item on the menu depends on instrument equipment

!

Items for "Limits" and "Analog output" are accessible only if incorporated in the instrument.



LIM L3 Setting boundary for limit 3

- contingent modification of hysteresis or delay may be performed in "PROFI" menu
- range of the setting is -99999...999999
- default "Hysteresis"=0 "Delay"=0

DEF = 60

Setting limit 3 > L 3 = 85 Example

60	61	62	63	64	65
65	75	85	MEMU		

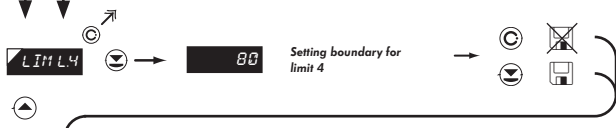

LIM L4 Setting boundary for limit 4

- contingent modification of hysteresis or delay may be performed in "PROFI" menu
- range of the setting is -99999...999999
- default "Hysteresis"=0 "Delay"=0

DEF = 80

Setting limit 4 > L 4 = 103 Example

80	81	82	83	83	93
83	003	103	MEMU		

* subsequent item on the menu depends on instrument equipment

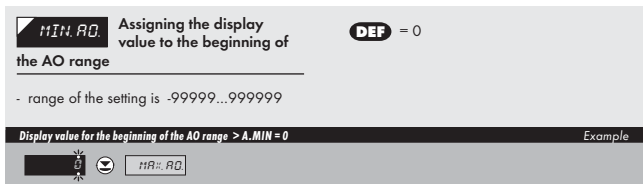
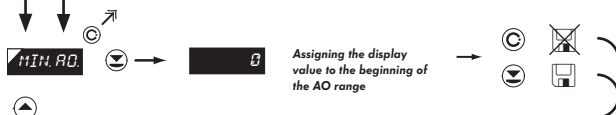
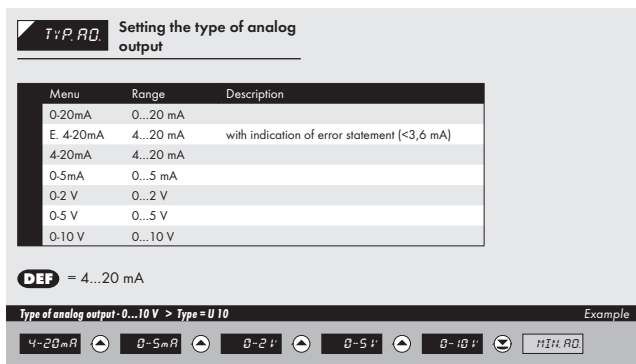
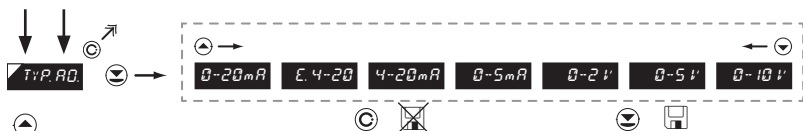

!

Items for "Limits" and "Analog output" are accessible only if incorporated in the instrument.

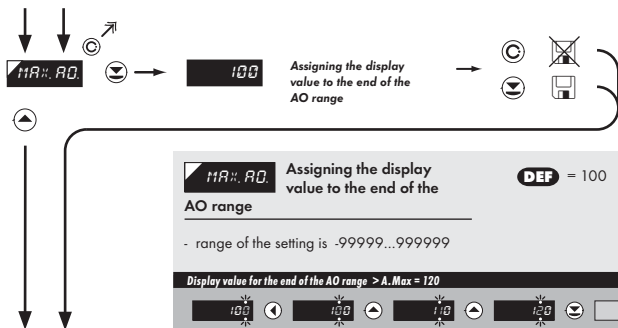

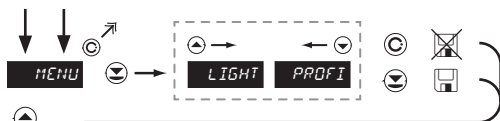

MENU Setting the menu type LIGHT/PROFI

LIGHT > menu LIGHT, a simple menu, which contains only the most essential items necessary for instrument setting
> linear tree structure

PROFI > menu PROFI, a complete menu for complete instrument setting
> tree menu structure

DEF = LIGHT

Menu LIGHT > MENU = LIGHT

Example

LIGHT RESTOR.



RESTOR. Restoration of manufacture instrument setting

- in the event of error setting or calibration it is feasible to restore manufacture setting. Prior

to execution of any modifications you will be asked to confirm your selection. (YES)
- loading manufacture calibration and primary setting of items on the menu (DEF)

Restoration of manufacture setting > RESTOR.

Example

RESTOR. YES LANG.

* subsequent item on the menu depends on instrument type, for "DU" > "K_MIN"

Type „DC“	36
Type "PM"	36
Type "DU"	35
Type "OHM"	36
Type "RTD-Pt"	36
Type "RTD-Ni"	36
Type "T/C"	36

Type "DU"

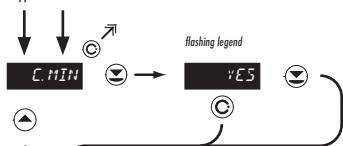

C.MIN Calibration of input range -
the potentiometer traveller
in initial position

Only for type "DU"

- prior confirming the flashing "YES" sign the potentiometer traveller has to be in given idle position

Calibration of the beginning of the range > C. MIN

Example

YES C.MAX

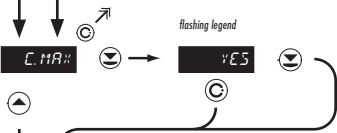

C.MAX Calibration of input range -
the potentiometer traveller
in end position

Only for type "DU"

- prior confirming the flashing "YES" sign the potentiometer traveller has to be in given idle position

Calibration of the end of the range > C. MAX

Example

YES LANG

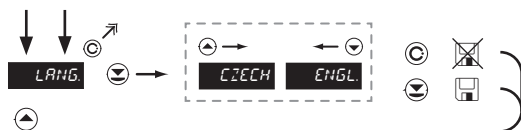

LANG. Selection of language in instrument menu

- selection of language version of the instrument menu

DEF = ENGL.

Language selection - ENGLISH > LANG. = ENGL. Example

CZECH ▲ ENGL ▼ N.PASS



N.PASS. Setting new access password

- access password for menu LIGHT/PROFI
- range of the number code 0...9999

upon setting the password to "000" the access to menu LIGHT/PROFI is free without prompt to enter it

in the event of loss universal password "8177" may be used

DEF = 0

New password - 341 > N.PASSW. = 341 Example

0 ▲ 1 ▲ 01 ▲ 2 ▲ 3 ▲ 4 ▲

4 ▼ 04 ▼ 14 ▼ 24 ▼ 34 ▼

ENTER

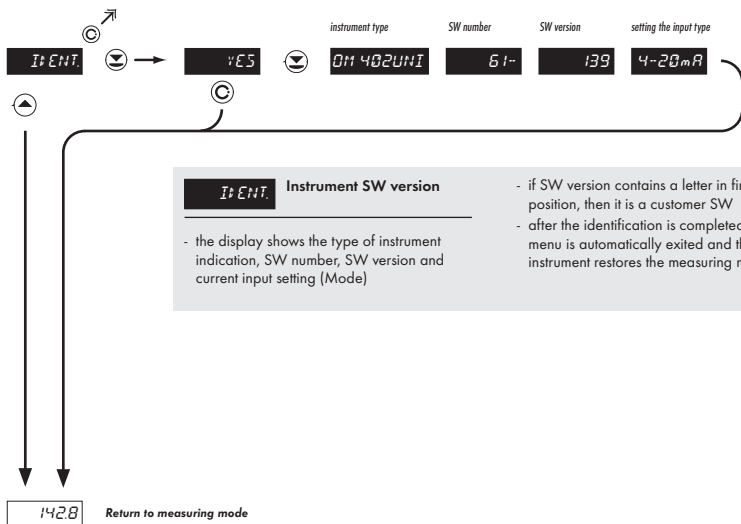

6.0

Setting "PROFI"

PROFI

Complete programming menu

- contains complete instrument menu and is protected by optional number code
- designed for expert users
- preset from manufacture is menu **LIGHT**

 SETTING
PROFI



- For expert users
- Complete instrument menu
- Access is password protected
- Possibility to arrange items of the „User“ menu
- Tree menu structure

Switching over to "PROFI" menu



- temporary switch-over to **PROFI** menu, which is suitable to edit a few items
- after quitting **PROFI** menu the instrument automatically switches to **LIGHT** menu
- access is password protected (if it was not set under item N. PASS. =0)



- access into **LIGHT** menu and transition to item „MENU“ with subsequent selection of „PROFI“ and confirmation
- after re-entering the menu the **PROFI** type is active
- access is password protected (if it was not set under item N. PASS. =0)

6.1 Setting "PROFI" - INPUT

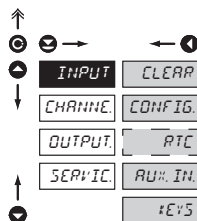

The primary instrument parameters are set in this menu

CLEAR	Resetting internal values
CONFIG	Selection of measuring range and parameters
RTC	Setting date and time for option with RTC
RU:: IN	Setting external inputs functions
*EVS	Assigning further functions to keys on the instrument

6.1.1 Resetting internal values

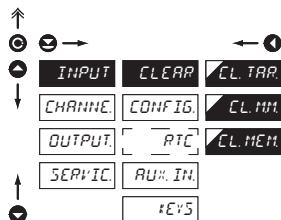

CLEAR	Resetting internal values
CL.TAR	Tare resetting
CL.MN	Resetting min/max value
CL.MEM	Resetting the instrument memory

- resetting memory for the storage of minimum and maximum value achieved during measurement
- resetting memory with data measured in the "FAST" or "RTC" modes
- not in standard equipment

6.1.2a Selection of measuring rate

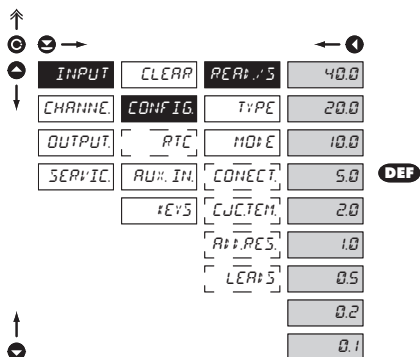

REAR:RS Selection of measuring rate

40.0	40,0 measurements/s
20.0	20,0 measurements/s
10.0	10,0 measurements/s
5.0	5,0 measurements/s
2.0	2,0 measurements/s
1.0	1,0 measurement/s
0.5	0,5 measurements/s
0.2	0,2 measurements/s
0.1	0,1 measurements/s

6.1.2b Selection of „instrument“ type

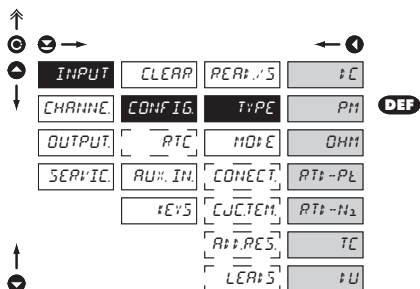

TYPE Selection of „instrument“ type

- selection of particular type of „instrument“ is bound to relevant dynamic items

VC	DC voltmeter
PH	Process monitor
OHM	Ohmmeter
RT:-PL	Thermometer for Pt xxx
RT:-Ni	Thermometer for Ni xxxx
TC	Thermometer pro thermocouples
VU	Display for linear potentiometers

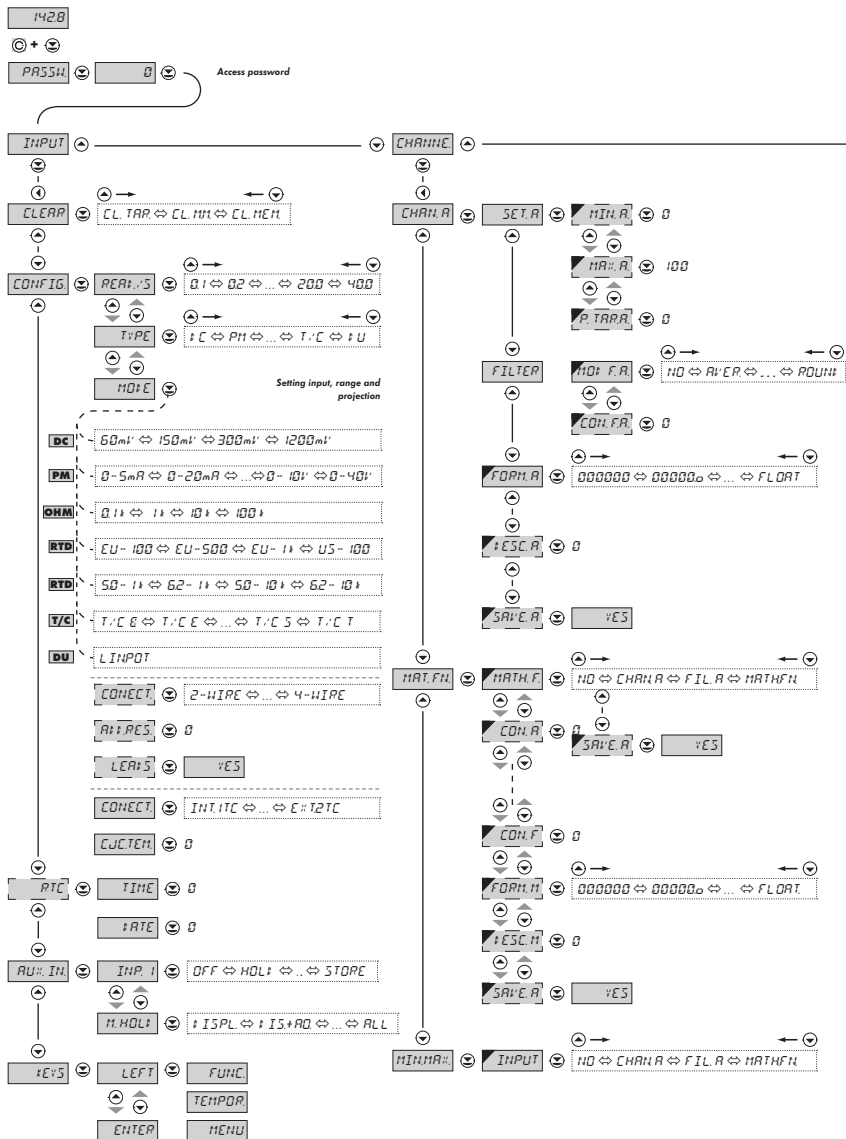

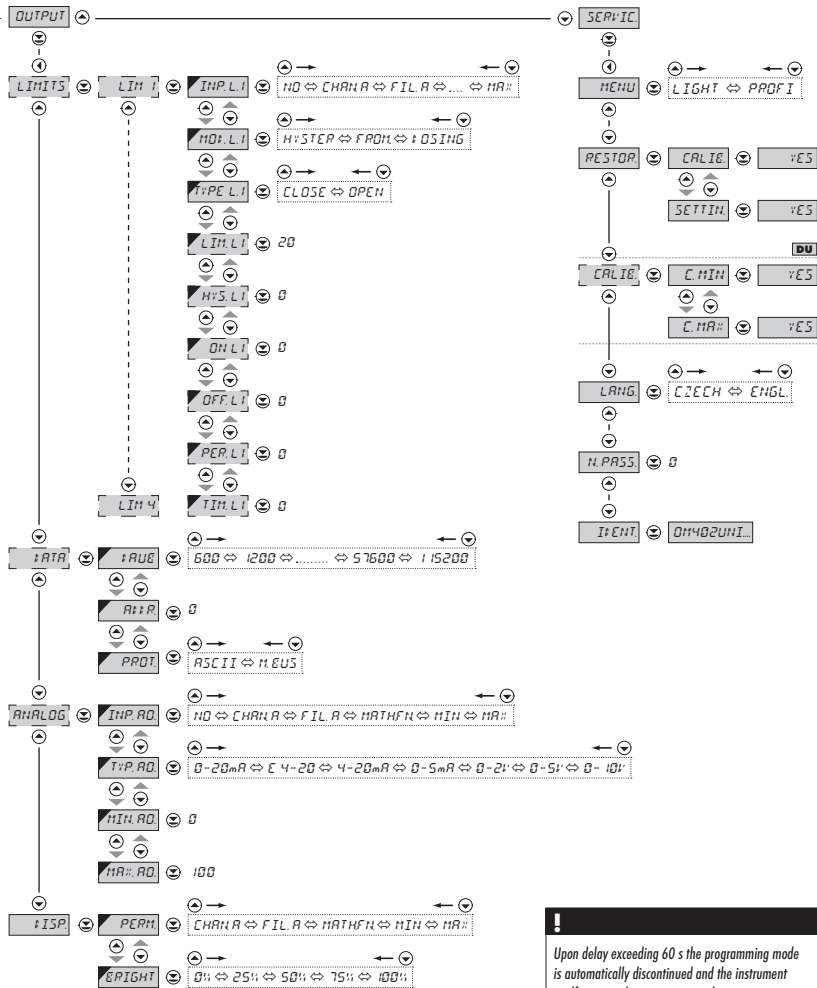

! Upon delay exceeding 60 s the programming mode is automatically discontinued and the instrument itself restores the measuring mode

6.1.2d Selection of type of sensor connection

RTD **OHM** **T/C**

↑
 Ⓞ →
 Ⓢ →
 ↓

INPUT	CLEAR	REAR.P/S	2-WIRE	DEF
CHANNE.	CONFIG	TYPE	3-WIRE	
OUTPUT	PTC	MODE	4-WIRE	
SERVIC.	AUX. IN.	CONNECT.		
	KEYS	ARR.RES.		
		LEAFS		

↑
 Ⓞ →
 Ⓢ →
 ↓

INPUT	CLEAR	REAR.P/S	INT.1TC	DEF
CHANNE.	CONFIG	TYPE	INT.2TC	
OUTPUT	PTC	MODE	EXT.1TC	
SERVIC.	AUX. IN.	CONNECT.	EXT.2TC	
	KEYS	CJC.TEM.		

CONNECT Selection of type of sensor connection

RTD **OHM**

2-WIRE 2-wire connection

3-WIRE 3-wire connection

4-WIRE 4-wire connection

T/C

INT.1TC Measurement without reference thermocouple

- measuring cold junction at instrument brackets

INT.2TC Measurement with reference thermocouple

- measuring cold junction at instrument brackets with anti-series connected reference thermocouple

EXT.1TC Measurement without reference thermocouple

- the entire measuring set is working under invaried and constant temperature

EXT.2TC Measurement with reference thermocouple

- when using compensation box



Method and procedure of setting the cold junctions is described in separate chapter on page 74



For thermocouple type "B" the items CONNECT. and CJC.TEM. are not available

6.1.3 Setting the real time clock

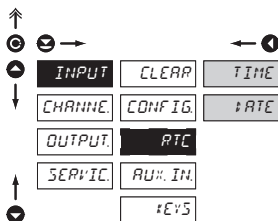

RTC Setting the real time clock (RTC)

TIME Time setting

- format 23.59.59

DATE Date setting

- format DD.MM.YY

6.1.4a External input function selection

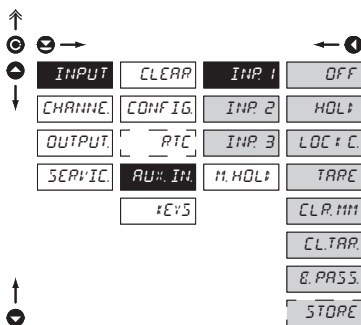

AU#: IN. External input function selection

OFF Input is off

HOLD Activation of HOLD

LOC K. Locking keys on the instrument

TARE Tare activation

CLR. MIN Resetting min/max value

CL. TARE Tare resetting

E. PASS. Activation of locking access into programming menu LIGHT/PROFI

STORE Activation of measured data record in instrument memory (not in standard equipment)

- **DEF** INPUT 1 > HOLD
- **DEF** INPUT 2 > LOCK K.
- **DEF** INPUT 3 > TARE

*

Setting procedure is identical for Input 2 and Input 3

6.1.4b Selection of function "HOLD"

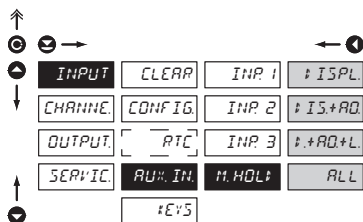

M. HOLD Selection of function "HOLD"

- ↑ISPL. "HOLD" locks only the value displayed
- ↑IS+RD. "HOLD" locks the value displayed and on AO
- ↑+RD+L. "HOLD" locks the value displayed, on AO and limit evaluation
- ALL "HOLD" locks the entire instrument

6.1.5a Optional accessory functions of the keys

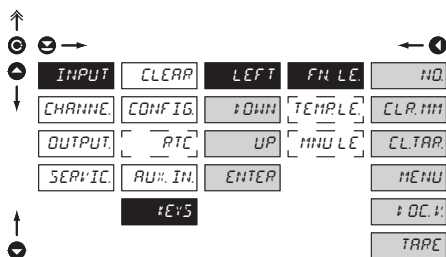

FN. LE. Assigning further functions to instrument keys

- „FUNC.“ > executive functions
- „TEMPOR.“ > temporary projection of selected values
- „MENU“ > direct access into menu on selected item

- NO. Key has no further function
- CLR.MM. Resetting min/max value
- CL.TAR. Tare resetting
- MENU. Direct access into menu on selected item
 - after confirmation of this selection the "MENU" item is displayed on superior menu level, where required selection is performed
- TEMP.V. Temporary projection of selected values
 - after confirmation of this selection the item "TEMPOR." is displayed on superior menu level, where required selection is performed
- TARE. Tare function activation



Setting is identical for LEFT, DOWN, UP and ENTER

6.1.5b Optional accessory functions of the keys - Temporary projection

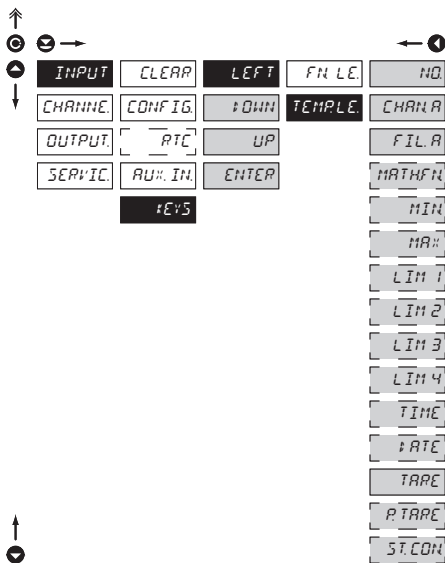

TEMPLE. Temporary projection of selected item

- "Temporary" projection of selected value is displayed for the time of keystroke
- "Temporary" projection may be switched to permanent by pressing **⊙** + "Selected key", this holds until the stroke of any key

NO.	Temporary projection is off
CHAN A	Temporary projection of "Channel A" value
FIL A	Temporary projection of "Channel A" value after processing digital filters
MATH.FN.	Temporary projection of "Mathematic functions" value
MIN	Temporary projection of "Min. value"
MAX	Temporary projection of "Max. value"
LIM 1	Temporary projection of "Limit 1" value
LIM 2	Temporary projection of "Limit 2" value
LIM 3	Temporary projection of "Limit 3" value
LIM 4	Temporary projection of "Limit 4" value
TIME	Temporary projection of "TIME" value
DATE	Temporary projection of "DATE" value
TARE	Temporary projection of "TARE" value
P.TARE	Temporary projection of "P. TARE" value
CJC.CON.	Temporary projection of "CJC" value

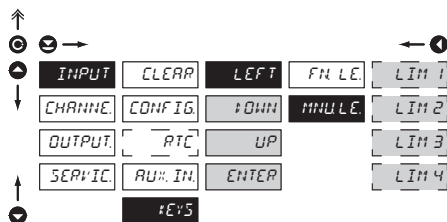

Setting is identical for **LEFT**, **DOWN**, **UP** and **ENTER**

6.1.5c Optional accessory functions of the keys - Direct access to item

MINU LE Assigning access to selected menu item

- LIM 1** Direct access to item "LIM 1"
- LIM 2** Direct access to item "LIM 2"
- LIM 3** Direct access to item "LIM 3"
- LIM 4** Direct access to item "LIM 4"



Setting is identical for LEFT, DOWN, UP and ENTER

6.2 Setting "PROFI" - CHANNELS

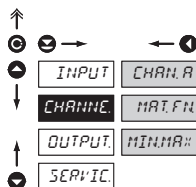

The primary instrument parameters are set in this menu

- CHAN.N** Setting parameters of measuring "Channel"
- MAT.FN.** Setting parameters of mathematic functions
- MIN.MA.:** Selection of access and evaluation of Min/max value

6.2.1a Display projection

DC PM DU OHM

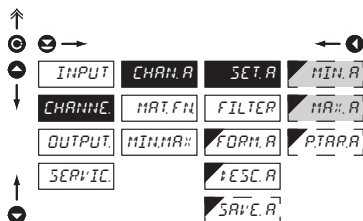

SET.A Setting display projection

- MIN.A.** Setting display projection for minimum value of input signal
 - range of the setting is -99999...999999
 - **DEF** = 0

- MA.X.A.** Setting display projection for maximum value of input signal
 - range of the setting is -99999...999999
 - **DEF** = 100

6.2.1b Setting fixed tare

DC PM DU OHM

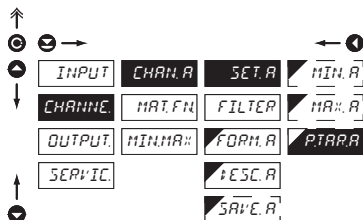

P.TAR.A Setting "Fixed tare" value

- setting is designed for the event when it is necessary to firmly shift the beginning of the range by known size
- when setting (P. TAR. A > 0) display shows "T" symbol
- range of the setting is 0...999999
- **DEF** = 0

6.2.1c Digital filters

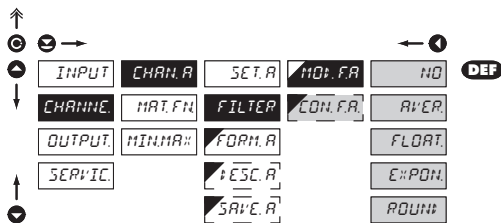

HOLD.F.A. Selection of digital filters

- at times it is useful for better user projection of data on display to modify it mathematically and properly, wherefore the following filters may be used:

NO Filters are off

AVER. Measured data average

- arithmetic average from given number („CON.F.A.“) of measured values
- range 2...100

FLOAT. Selection of floating filter

- floating arithmetic average from given number („CON.F.A.“) of measured data and updates with each measured value
- range 2...30

EXPON. Selection of exponential filter

- integration filter of first prvnho grade with time constant („CON.F.A.“) measurement
- range 2...100

ROUND. Measured value rounding

- is entered by any number, which determines the projection step (e.g: "CON.F.A."=2,5 > display 0, 2,5, 5,...)

CON.F.A. Setting constants

- this menu item is always displayed after selection of particular type of filter

DEF = 2

6.2.1d Projection format - positioning of decimal point

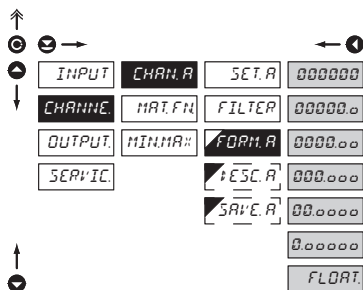

FORM.A Selection of decimal point

- the instrument allows for classic projection of a number with positioning of the DP as well as projection with floating DP, allowing to display a number in its most exact form „FLOAT.P.“

000000

Setting DP - XXXXXX.

00000.0

Setting DP - XXXXX.x

- **DEF** > **RTD** **T/C**

0000.00

Setting DP - XXXX.xx

- **DEF** > **DC** **PM** **DU** **OHM**

000.000

Setting DP - XXX.xxx

00.0000

Setting DP - XX.xxxx

0.00000

Setting DP - X.xxxxx

FLOAT.P.

Floating DP

6.2.1e Projection of description - the measuring units

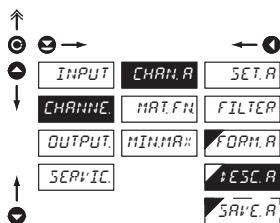

ESC.A Setting projection of descrpt. for "Channel A"

- projection of measured data may be extended (at the expense of the number of displayed places) by two characters for description
- description is set by shifted ASCII code, when two first places show the set description and two last characters their code in period 0...95
- description is cancelled by code 00
- **RTD** **T/C** **DEF** = °C
- **DC** **PM** **DU** **OHM** **DEF** =none



Table of signs on page 77

6.2.1f Selection of storing data into instrument memory

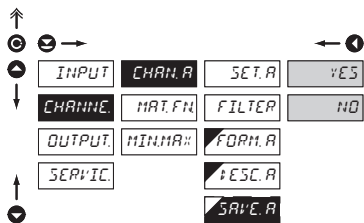

SAVE.A Selection of storing data into instrument memory

- by selection in this item you allow to register values into instrument memory
- another setting in item "OUTPUT > MEMORY" (not in standard experiment)

YES Measured data are stored in the memory

NO Measured data are not stored

6.2.2a Mathematic functions

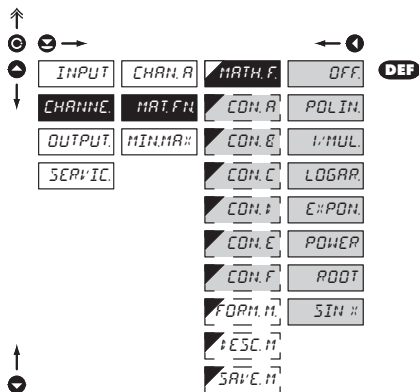
**MATH.F.** Selection of mathematic functions**OFF.**

Mathematic functions are off

POLIN

Polynome

$$Ax^5 + Bx^4 + Cx^3 + Dx^2 + Ex + F$$

1/MUL.

1/x

$$\frac{A}{x^5} + \frac{B}{x^4} + \frac{C}{x^3} + \frac{D}{x^2} + \frac{E}{x} + F$$

LOGAR.

Logarithm

$$A \times \ln\left(\frac{Bx + C}{Dx + E}\right) + F$$

EXPON.

Exponential

$$A \times e^{\left(\frac{Bx+C}{Dx+E}\right)} + F$$

POWER

Power

$$A \times (Bx + C)^{(Dx+E)} + F$$

ROOT

Root

$$A \times \sqrt{\frac{Bx + C}{Dx + E}} + F$$

SIN #

Sin x

$$A \sin^5 x + B \sin^4 x + C \sin^3 x + D \sin^2 x + E \sin x + F$$

CON. -

Setting constants for calculation of mat. functions

- this menu is displayed only after selection of given mathematic function

6.2.2b Mathematic functions - decimal point

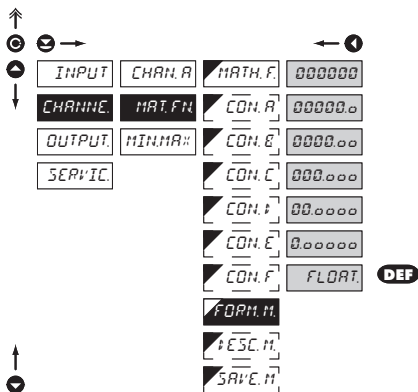

FORM.H. Selection of decimal point

- the instrument allows for classic projection of a number with positioning of the DP as well as projection with floating DP, allowing to display a number in its most exact form „FLOAT.P.“

000000. Setting DP - XXXXXX.

00000.0 Setting DP - XXXXX.x

0000.00 Setting DP - XXXX.xx

000.000 Setting DP - XXX.xxx

00.0000 Setting DP - XX.xxxx

0.00000 Setting DP - X.xxxxx

FLOAT.P. Floating DP

DEF

6.2.2c Mathematic functions - measuring units

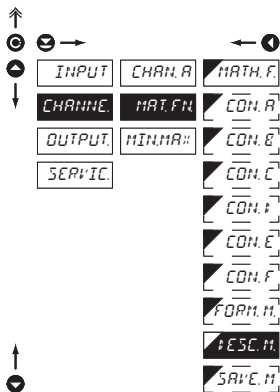

+ESC.H. Setting projection of description for "MAT.FN"

- projection of measured data may be extended (at the expense of the number of displayed places) by two characters for description
- description is set by shifted ASCII code, when two first places show the set description and two last characters their code in period 0...95
- description is cancelled by code 00

DEF = no description

!

Table of signs on page 77

6.2.2d Mathematic functions - selection of storing data into instrument memory

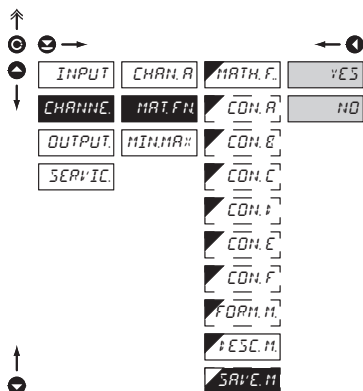
**SAVE.A** Selection of storing data into instrument memory

- by selection in this item you allow to register values into instrument memory
- another setting in item "OUTPUT > MEMORY" (not in standard experiment)

YES Measured data are stored in the memory

NO Measured data are not stored

6.2.3 Selection of evaluation of min/max value

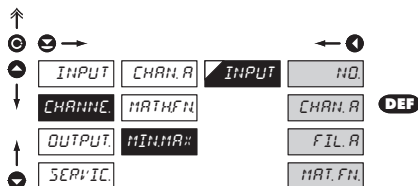
**INPUT** Selection of evaluation of min/max value

- selection of value from which the min/max value will be calculated

NO Evaluation of min/max value is off

CHAN.A From "Channel A"

FIL.A From "Channel A" after digital filters processing

MAT.FN From "Mathematic functions"

6.3 Setting „PROFI“ - OUTPUTS

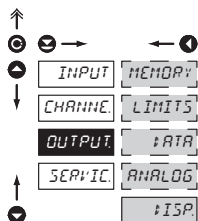

In this menu it is possible to set parameters of the instrument output signals

- MEMOR** Setting data logging into memory
- LIMITS** Setting type and parameters of limits
- :ATA** Setting type and parameters of data output
- ANALOG** Setting type and parameters of analog output
- :ISP** Setting display projection and brightness

6.3.1a Selection of mode of data logging into instrument memory

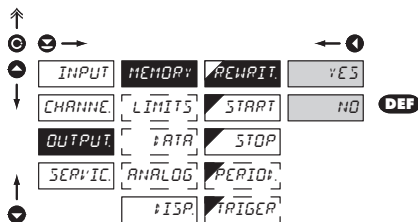

REWRIT Selection of the mode of data logging

- selection of the mode in the event of full instrument memory

- NO** Rewriting values prohibited
- YES** Rewriting values permitted, the oldest get rewritten by the latest

6.3.1b Setting data logging into instrument memory - RTC

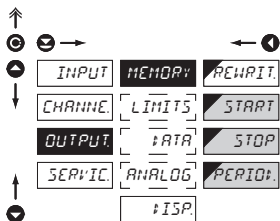

- START** Start of data logging into instrument memory
- time format HH.MM.SS
- STOP** Stop data logging into instrument memory
- time format HH.MM.SS
- PERIOD** Period of data logging into instrument memory
- determines the period in which values will be logged in an interval delimited by the time set under items START and STOP
- time data hold valid for one day, where the logging is valid for every day without limitation
- time format HH.MM.SS
- item not displayed if "STORE" is selected in menu (Input > AUX. IN.)

6.3.1c Setting data logging into instrument memory - FAST

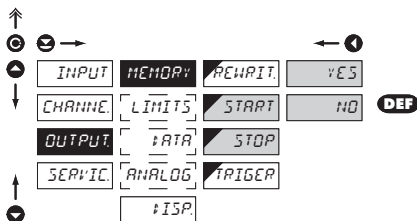

- START** Start of data logging into instrument memory
 - STOP** Stop data logging into instrument memory
- time format HH.MM.SS
 - TRIGGER** Setting logging data into inst. memory
- values will be logged in an interval delimited by the time set under items START and STOP, time data hold valid for one day, where the logging is valid for every day without limitation
- logging data into inst. memory is governed by the following selection, which determines how many percent of the memory is reserved for data logging prior to initiation of trigger impulse
- initiation is on ext. input or control key
- 10%** Reser. of 10 % memory prior init. of data logging
 - 50%** Reser. of 50 % memory prior init. of data logging
 - 90%** Reser. of 90 % memory prior init. of data logging
 - ROLL** After initiation of data logging the memory is cyclically transcribed

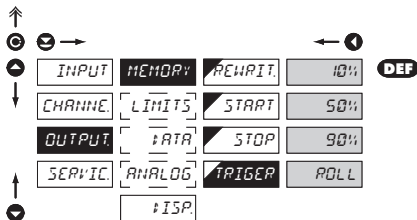

6.3.2a Selection of input for limits evaluation

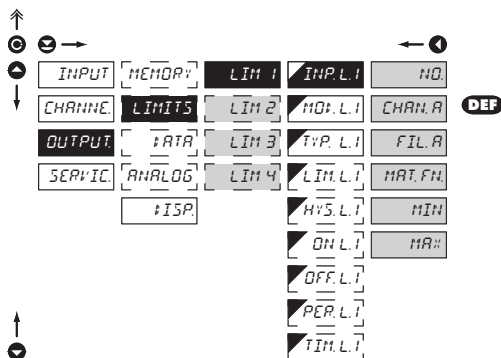

Setting is identical for LIM 2, LIM 3 and LIM 4

INP.L.1 Selection evaluation of limits

- selection of value from which the limit will be evaluated

- NO** Limit evaluation is off
- CHAN.A** Limit evaluation from "Channel A"
- FIL.A** Limit evaluation from "Channel A" after digital filters processing
- MAT.FN.** Limit evaluation from "Mathematic functions"
- MIN.** Limit evaluation from "Min.value"
- MAX.** Limit evaluation from "Max.value"

6.3.2b Selection of type of limit

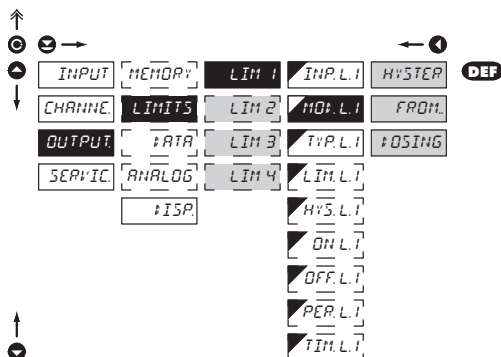

Setting is identical for LIM 2, LIM 3 and LIM 4

HYS.TER Selection the type of limit

- HYS.TER** Limit is in mode "Limit, hysteresis, delay"
 - for this mode the parameters of "LIM. L." are set, at which the limit will shall react, "HYS. L." the hysteresis range around the limit ($LIM \pm 1/2 HYS$) and time "TIM. L." determining the delay of relay switch-on
- FROD.** Frame limit
 - for this mode the parameters are set for interval "ON. L." the relay switch-on and "OFF. L." the relay switch-off
- OSING** Dose limit (periodic)
 - for this mode the parameters are set for "PER. L." determining the limit value as well as its multiples at which the output is active and "TIM. L." indicating the time during which is the output active

6.3.2c Selection of type of output

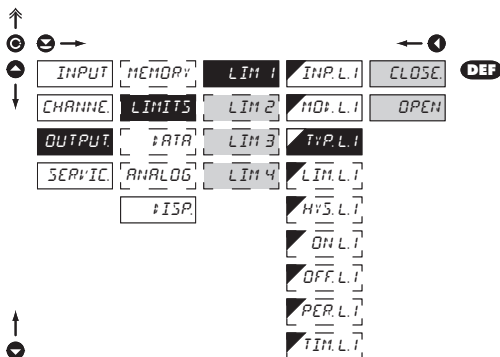

TYP.L.1 Selection of type of output

CLOSE Output switches on when condition is met

OPEN Output switches off when condition is met

Setting is identical for LIM 2, LIM 3 and LIM 4

6.3.2d Setting values for limits evaluation

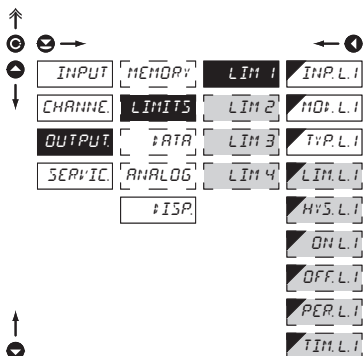

LIM.L.1 Setting limit for switch-on

- for type "HYSTER"

HYS.L.1 Setting hysteresis

- for type "HYSTER"
- indicates the range around the limit (in both directions, LIM. $\pm 1/2$ HYS.)

ON.L.1 Setting the outset of the interval of limit switch-on

- for type "FROM"

OFF.L.1 Setting the end of the interval of limit switch-on

- for type "FROM"

PER.L.1 Setting the period of limit switch-on

- for type "DOSE"

TIM.L.1 Setting the time switch-on of the limit

- for type "HYSTER" and "DOSE"

Setting is identical for LIM 2, LIM 3 and LIM 4

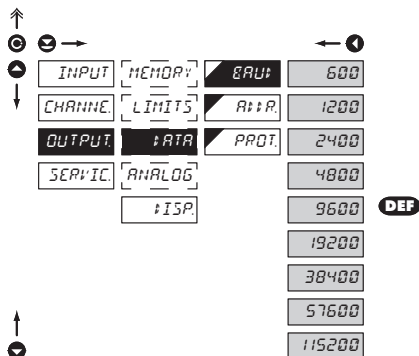
6.3.3a Selection of data output baud rate

BAUD Selection of data output baud rate

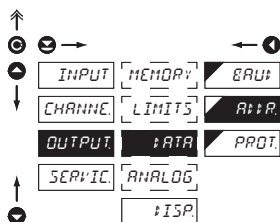
600	Rate - 600 Baud
1200	Rate - 1 200 Baud
2400	Rate - 2 400 Baud
4800	Rate - 4 800 Baud
9600	Rate - 9 600 Baud
19200	Rate - 19 200 Baud
38400	Rate - 38 400 Baud
57600	Rate - 57 600 Baud
115200	Rate - 115 200 Baud

6.3.3b Setting instrument address

Rt:P Setting instrument address

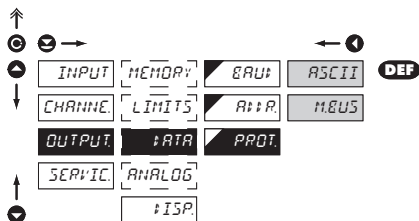
- setting in range 0...31
- **DEF** = 00

6.3.3c Selection of data output protocol



PROT. Selection of the type of analog output

- ASCII Data protocol ASCII
- M.BUS Data protocol DIN MessBus

6.3.4a Selection of input for analog output

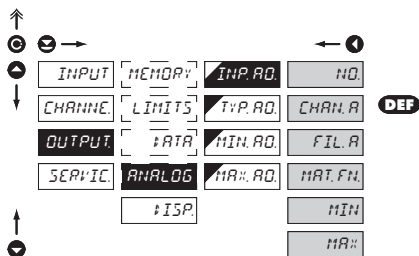

INP. AD. Selection evaluation analog output

- selection of value from which the analog output will be evaluated

- NO AO evaluation is off
- CHAN. A AO evaluation from "Channel A"
- FIL. A AO evaluation from "Channel A" after digital filters processing
- MAT. FN. AO evaluation from "Math.functions"
- MIN. AO evaluation from "Min.value"
- MAX. AO evaluation from "Max.value"

6.3.4b Selection of the type of analog output

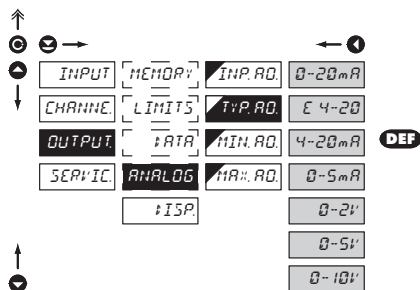
**TYP. RD.** Selection of the type of analog output

0-20 mA Type - 0...20 mA

E 4-20 Type - 4...20 mA

- with indication of error statement (< 3,0 mA)

4-20 mA Type - 4...20 mA

0-5 mA Type - 0...5 mA

0-2 V Type - 0...2 V

0-5 V Type - 0...5 V

0-10 V Type - 0...10 V

6.3.4c Setting the analog output range

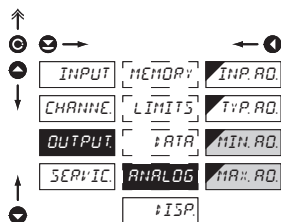
**ANALOG** Setting the analog output range

- analog output is isolated and its value corresponds with displayed data. It is fully programmable, i.e. it allows to assign the AO limit points to two arbitrary points of the entire measuring range

MIN. RD. Assigning the display value to the beginning of the AO range

- range of the setting is -99999...999999

- **DEF** = 0

MA#. RD. Assigning the display value to the end of the AO range

- range of the setting is -99999...999999

- **DEF** = 100

6.3.5a Selection of input for display projection

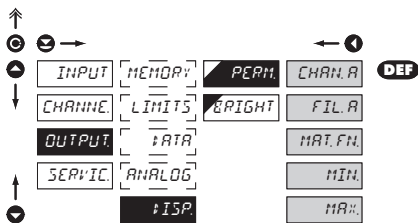

INPUT Selection display projection

- selection of value which will be shown on the instrument display

- CHAN. A** Projection of values from "Channel A"
- FIL. A** Projection of values from "Channel A" after digital filters processing
- MAT. FN.** Projection of values from "Math.functions"
- MIN.** Projection of values from "Min.value"
- MAX.** Projection of values from "Max.value"

6.3.5b Selection of display brightness

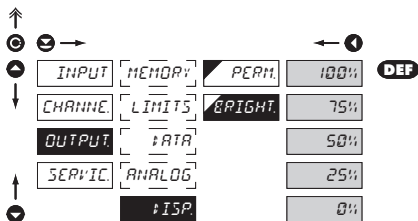

BRIGHT Selection of display brightness

- by selecting display brightness we may appropriately react to light conditions in place of instrument location

- 0%** Display is off
- after keystroke display turns on for 10 s
- 25%** Display brightness - 25%
- 50%** Display brightness - 50%
- 75%** Display brightness - 75%
- 100%** Display brightness - 100%

6.4 Setting "PROFI" - SERVIS

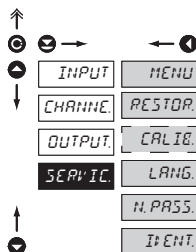

The instrument service functions are set in this menu

MENU	Selection of menu type LIGHT/PROFI
RESTOR	Restore instrument manufacture setting and calibration
CALIB	Input range calibration for „DU“ version
LANG	Language version of instrument menu
N.PASS	Setting new access password
IDENT	Instrument identification

6.4.1 Selection of type of programming menu

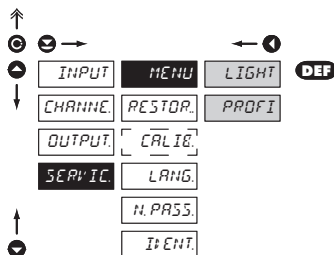

MENU Selection of menu type - LIGHT/PROFI

- enables setting the menu complexity according to user needs and skills

LIGHT Active LIGHT menu

- simple programming menu, contains only items necessary for configuration and instrument setting
- linear menu > items one after another

PROFI Active PROFI menu

- complete programming menu for expert users
- tree menu



Change of setting is valid upon next access into menu

6.4.2 Restoration of manufacture setting

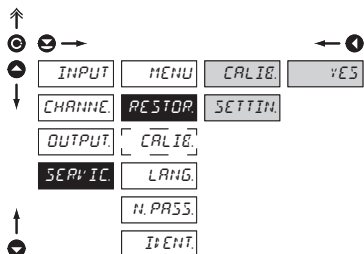

RESTOR. Restoring manufacture setting of the instrument

- in the event of erroneous setting or calibration it is feasible to restore manufacture setting. Prior execution of any changes you will be asked to confirm your preference „YES“

CALIB. Restore manufacture instrument calibration

SETTIN. Restore manufacture instrument setting

- loading manufacture setting (items denoted DEF)
- prior execution of changes you will be asked to confirm your preference “YES”

6.4.3 Calibration - Input range

DU

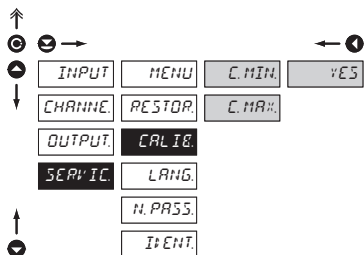

CALIB. Input range calibration

- when “C. MIN.” is displayed, move the potentiometer traveller to the required minimum position and confirm by „Enter“, calibration is confirmed by “YES”
- when “C. MAX.” is displayed, move the potentiometer traveller to required maximum position and confirm by „Enter“, calibration is confirmed by „YES“

6.4.4 Selection of instrument menu language version

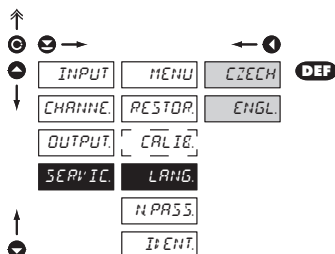

LANG. Selection of instrument menu language version

CZECH Instrument menu is in Czech

ENGL. Instrument menu is in English

6.4.5 Setting new access password

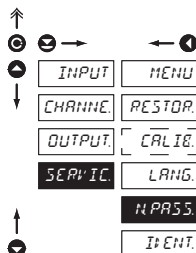

N.PASS. Setting new password for access to LIGHT and PROFI menu

- this selection enables changing number code that blocks the access into LIGHT and PROFI Menu.
- range of the number code is 0...9999
- universal password in the event of loss is „8177“

6.4.6 Instrument identification

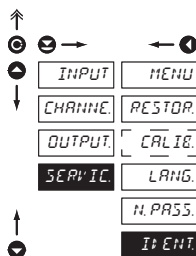

I:ENT. Projection of instrument SW version

- display shows type identification of the instrument, SW number, SW version and current input setting (Mode)
- if the SW version reads a letter on first position, it is a customer SW

7.0 Setting items into "USER" menu

- **USER** menu is designed for users who need to change only several items of the setting without the option to change the primary instrument setting (e.g. repeated change of limit setting)
- there are no items from manufacture permitted in **USER** menu
- on items indicated by inverse triangle  L I
- setting may be performed in **LIGHT** or **PROFI** menu, with the **USER** menu then overtaking the given menu structure

Setting
USER

- For user operation
- Menu items are set by the user (Profi/Light) as per request
- Access is not password protected

Setting

flashing legend - current setting is displayed



NO

item will not be displayed in USER menu

YES

item will be displayed in USER menu with editing option

SHOW

item will be solely displayed in USER menu

Setting sequence of items in "USER" menu

In compiling USER menu from active LIGHT menu the items (max. 10) may be assigned a sequence, in which they will be projected in the menu



Example:

Into USER menu were selected these items

(keys \odot + \blacktriangle) > CL. TAR., LIM 1, LIM 2, LIM 3, for which we have preset this sequence (keys \odot + \blacktriangledown):

CL. TAR.	5
LIM 1	0 (sequence not determined)
LIM 2	2
LIM 3	1

Upon entering USER menu

(key \odot) items will be projected in the following sequence: LIM 3 > LIM 2 > CL.TAR. > LIM 1

Instrument with input for temperature measurement with thermocouple allows to set two types of measurement of cold junction.

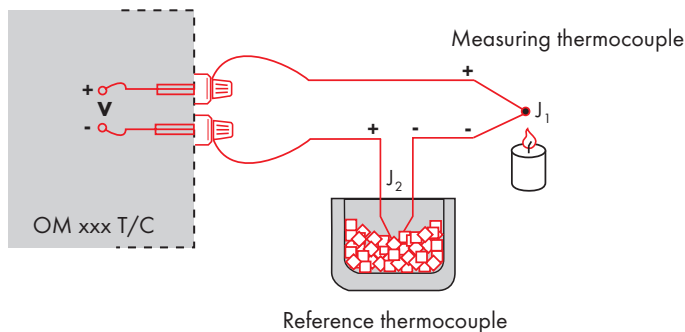

WITH REFERENCE THERMOCOUPLE

- a reference thermocouple may be located in the same place as the measuring instrument or in place with stable temperature/compensation box
- when measuring with reference thermocouple set *CONNECT* in the instrument menu to *INT2TC* or *E::T2TC*
- when using a thermostat (a compensation box or environment with constant temperature) set in the instrument menu *JUL.TEM*, its temperature (applies for setting *CONNECT* to *E::T2TC*)
- if the reference thermocouple is located in the same environment as the measuring instrument then set in the instrument menu *CONNECT* to *INT2TC*. Based on this selection the measurement of the ambient temperature is performed by a sensor located in the instrument terminal board.

WITHOUT REFERENCE THERMOCOUPLE

- inaccuracy originating from the creation of dissimilar thermocouples on the transition point terminal/conductor of the thermocouple is not compensated for in the instrument
- when measuring without reference thermocouple set *CONNECT* in the instrument menu to *INT1TC* or *E::T1TC*
- when measuring temperature without reference thermocouple the error in measured data may be as much as 10°C (applies for setting *CONNECT* to *E::T1TC*)

The instruments communicate via serial line RS232 or RS485. For communication they use the ASCII protocol. Communication runs in the following format:

ASCII: 8 bit, no parity, one stop bit
 DIN MessBus: 7 bit, even parity, one stop bit

The transfer rate is adjustable in the instrument menu. The instrument address is set in the instrument menu in the range of 0 + 31. The manufacture setting always presets the ASCII protocol, rate of 9600 Baud, address 00. The type of line used - RS232 / RS485 - is determined by an output board automatically identified by the instrument. The commands are described in specification you can find at www.orbit.merret.cz/rs.

DETAILED DESCRIPTION OF COMMUNICATION VIA SERIAL LINE

Activity	Data transferred										
Data solicitation (PC)	#	A	A	<CR>							
Data transmission (Instrument)	>	R	<SP>	D	D	D	D	D	(D)	(D)	<CR>
Command confirm. (Instr.) - OK	!	A	A	<CR>							
Command confirm. (Instr.) - Bad	?	A	A	<CR>							
Instrument identification	#	A	A	1Y	<CR>						
HW identification	#	A	A	1Z	<CR>						
One-time measurement	#	A	A	7X	<CR>						
Repeated measurement	#	A	A	8X	<CR>						

LEGEND

#	35	23 _H	Command beginning
A	A	0...31	Two signs of instrument address (sent in ASCII - tens and ones, e.g. "01", "99" universal
<CR>	13	0D _H	Carriage return
<SP>	32	20 _H	Space
D			Data - usually signs "0"... "9", ".", "-", ";"; (D) - DP. and (-) may prolong data
R	50 _H ...57 _H		Relay and Tare status
!	33	21 _H	Positive command confirmation (ok)
?	63	3F _H	Negative command confirmation (bad)
>	62	3E _H	Beginning of the data transmitted

RELAY, TARE

Sign	Relay 1	Relay 2	Tare	Change relay 3/4
P	0	0	0	0
Q	1	0	0	0
R	0	1	0	0
S	1	1	0	0
T	0	0	1	0
U	1	0	1	0
V	0	1	1	0
W	1	1	1	0
p	0	0	0	1
q	1	0	0	1
r	0	1	0	1
s	1	1	0	1
t	0	0	1	1
u	1	0	1	1
v	0	1	1	1
w	1	1	1	1

ERROR	CAUSE	ELIMINATION
<i>E. P. U n</i>	Number is too small (large negative) to be displayed	change DP setting, channel constant setting
<i>E. P. O n.</i>	Number is too large to be displayed	change DP setting, channel constant setting
<i>E. T. U n</i>	Number is outside the table range	increase table values, change input setting (channel constant setting)
<i>E. T. O n.</i>	Number is outside the table range	increase table values, change input setting (channel constant setting)
<i>E. I. U n</i>	Input quantity is smaller than permitted input quantity range	change input signal value or input (range) setting
<i>E. I. O n.</i>	Input quantity is larger than permitted input quantity range	change input signal value or input (range) setting
<i>E. HH</i>	A part of the instrument does not work properly	send the instrument for repair
<i>E. EE</i>	Data in EEPROM corrupted	perform restoration of manufacture setting, upon repeated error statement send instrument for repair
<i>E. P. AT n</i>	Data in EEPROM outside the range	perform restoration of manufacture setting, upon repeated error statement send instrument for repair
<i>E. CLR.</i>	Memory was empty (presetting carried out)	upon repeated error statement send instrument for repair, possible failure in calibration

The instrument allows to add two descriptive characters to the classic numeric formats (at the expense of the number of displayed places). The setting is performed by means of a shifted ASCII code. Upon modification the first two places display the entered characters and the last two places the code of the relevant symbol from 0 to 95. Numeric value of given character equals the sum of the numbers on both axes of the table.

Description is cancelled by entering characters with code 00

0	0	1	2	3	4	5	6	7	0	1	2	3	4	5	6	7	
8	()	*	+	,	-	.	/	8	()	*	+	,	-	.	/
16	0	1	2	3	4	5	6	7	16	0	1	2	3	4	5	6	7
24	8	9	:	;	<	=	>	?	24	8	9	:	;	<	=	>	?
32	@	A	B	C	D	E	F	G	32	@	A	B	C	D	E	F	G
40	H	I	J	K	L	M	N	O	40	H	I	J	K	L	M	N	O
48	P	Q	R	S	T	U	V	W	48	P	Q	R	S	T	U	V	W
56	X	Y	Z	[\]	^	_	56	X	Y	Z	[\]	^	_
64	`	a	b	c	d	e	f	g	64	`	a	b	c	d	e	f	g
72	h	i	j	k	l	m	n	o	72	h	i	j	k	l	m	n	o
80	p	q	r	s	t	u	v	w	80	p	q	r	s	t	u	v	w
88	x	y	z	{		}	~		88	x	y	z	{		}	~	

INPUT

range is adjustable			DC
	±60 mV	>100 MOhm	Input U
	±150 mV	>100 MOhm	Input U
	±300 mV	>100 MOhm	Input U
	±1200 mV	>100 MOhm	Input U

range is adjustable			PM
	0/4...20 mA	< 400 mV	Input I
	±2 V	1 MOhm	Input U
	±5 V	1 MOhm	Input U
	±10 V	1 MOhm	Input U
	±40 V	1 MOhm	Input U

range is adjustable			OHM
	0...100 Ohm		
	0...1 kOhm		
	0...10 kOhm		
	0...100 kOhm		
Connection:	2, 3 or 4 wire		

			RTD
Pt xxxx	-200°...850°C		
Ni xxxx	-30,0°...199,9°C		
Type Pt:	100/500/1 000 Ohm, s 3850 ppm/°C		
	100 Ohm, s 3920 ppm/°C		
Type Ni:	Ni 1 000/ Ni 10 000 s 5000/6180 ppm/°C		
Connection:	2, 3 or 4 wire		

range is adjustable in configuration menu			T/C
Type:	J (Fe-CuNi)	-200°...900°C	
	K (NiCr-Ni)	-200°...1 300°C	
	T (Cu-CuNi)	-200°...400°C	
	E (NiCr-CuNi)	-200°...690°C	
	B (PtRh30-PtRh6)	300°...1 820°C	
	S (PtRh10-Pt)	-50°...1 760°C	
	R (Pt13Rh-Pt)	-50°...1 740°C	
	N (Omegalloy)	-200°...1 300°C	

Voltage of lin. pot.	2,5 VDC/6 mA		DU
	min. potentiometer resistance is 500 Ohm		

PROJECTION

Display:	999999, intensive red or green
	14-segment LED, digit height 14 mm
Projection:	±9999 (-99999...999999)
Decimal point:	adjustable - in menu
Brightness:	adjustable - in menu

INSTRUMENT ACCURACY

TC:	100 ppm/°C	
Accuracy:	±0,1 % of range + 1 digit	
	±0,15 % of range + 1 digit	RTD, T/C
	±0,3 % of range + 1 digit	PWR
	Above accuracies apply for projection 9999	

Resolution:	0,01°/0,1°/1°	RTD
Rate:	0,1...40 measurements/s	
Overload capacity:	10x (t < 100 ms) not for 400 V and 5 A, 2x (long-term)	
Linearisation:	by linear interpolation in 50 points - solely via OM Link	

Digital filters:	Averaging, Floating average, Exponential filter, Rounding	
Comp. of conduct:	max. 40 Ohm/100 Ohm	RTD
Comp. of cold junct.:	adjustable	T/C

Functions:	Tare - display resetting Hold - stop measuring (at contact) Lock - control key locking MM - min/max value Mathematic functions	
OM Link:	company communication interface for setting, operation and update of instrument SW	
Watch-dog:	reset after 400 ms	
Calibration:	at 25°C and 40 % of r.h.	

COMPARATOR

Type:	digital, adjustable in menu
Mode:	Hysteresis, From, Dose
Limita:	-99999...999999
Hysteresis:	0...999999
Delay:	0...99,9 s
Outputs:	2x relays with switch-on contact (Form A) (230 VAC/30 VDC, 3 A)* 2x relays with switch-off contact (Form C) (230 VAC/50 VDC, 3 A)*
Relay:	1/8 HP 277 VAC, 1/10 HP 125 V, Pilot Duty D300

DATA OUTPUTS

Protocols:	ASCII, DIN MessBus
Data format:	8 bit + no parity + 1 stop bit (ASCII) 7 bit + even parity + 1 stop bit (MessBus)
Rate:	600...115 200 Baud
RS 232:	isolated, two-way communication

* values apply for resistance load

RS 485:	isolated, two-way communication, addressing (max. 31 instruments)
PROFIBUS	Data protocol SIEMENS

ANALOGO OUTPUTS

Type:	isolated, programmable with resolution of max.10 000 points, analog output corresponds with displayed data, type and range are adjustable
Non-linearity:	0,2 % of range
TC:	100 ppm/°C
Rate:	response to change of value < 40 ms
Voltage:	0...2 V/5 V/10 V
Current:	0...5/20 mA/4...20 mA - compensation of conduct to 500 Ohm

MEASURED DATA RECORD

Type RTC:	time-controlled logging of measured data into instrument memory, allows to log up to 250 000 values
Type FAST:	fast data logging into instrument memory, allows to log up to 8 000 values at a rate of 40 records/s
Transmission:	via data output RS 232/485 or via OM Link

EXCITATION

Adjustable:	5...24 VDC/max. 1,2 W, isolated
-------------	---------------------------------

POWER SUPPLY

Options:	10...30 V AC/DC, 10 VA, isolated, - fuse inside (T 4000 mA) 80...250 V AC/DC, 10 VA, isolated - fuse inside (T 630 mA)
----------	---

MECHANIC PROPERTIES

Material:	Noryl GFN2 SE1, incombustible UL 94 V-1
Dimensions:	96 x 48 x 120 mm
Panel cut-out:	90,5 x 45 mm

OPERATING CONDITIONS

Connection:	connector terminal board, conductor cross-section <1,5 mm ² / <2,5 mm ²
Stabilisation period:	within 15 minutes after switch-on
Working temp.:	0°...60°C
Storage temp.:	-10°...85°C
Cover:	IP65 (front panel only)
Construction:	safety class I
Overvoltage category:	EN 61010-1, A2
Insulation resistance:	for pollution degree II, measurement category III AC instrum.power supply > 670 V (PI), 300 V (DI) DC instrum.power supply > 300 V (PI), 150 V (DI) Input/output > 300 V (PI), 150 (DI)
EMC:	EN 61000-3-2+A12; EN 61000-4-2, 3, 4, 5, 8, 11; EN 550222, A1, A2

PI - Primary insulation, DI - Double insulation

Front view



Panel cut

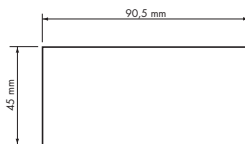

Side view

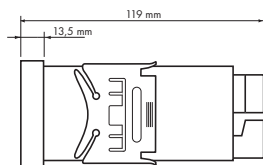

Panel thickness: 0,5...20 mm

Instrument installation

1. insert the instrument into the panel cut-out
2. fit both travellers on the box
3. press the travellers close to the panel

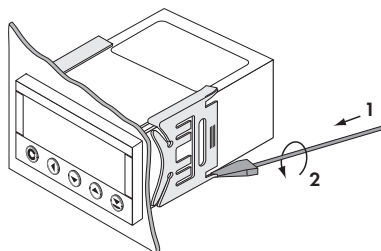
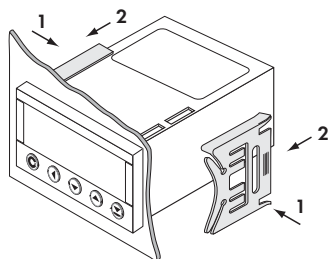

Instrument disassembly

1. slide a screw driver under the traveller wing
2. turn the screw driver and remove the traveller
3. take the instrument out of the panel

Product **OM 402UNI** **A B**
 Type
 Manufacturing No.
 Date of sale

GUARANTEE

A guarantee period of 24 months from the date of sale to the user applies to this instrument.

Defects occurring during this period due to manufacture error or due to material faults shall be eliminated free of charge.

For quality, function and construction of the instrument the guarantee shall apply provided that the instrument was connected and used in compliance with the instructions for use.

The guarantee shall not apply to defects caused by:

- mechanic damage
- transportation
- intervention of unqualified person incl. the user
- unavoidable event
- other unprofessional interventions

The manufacturer performs guarantee and post.guarantee repairs unless provided for otherwise.

Y E A R S

Stamp, signature

DECLARATION OF CONFORMITY

Company: **ORBIT MERRET, spol. s r.o.**
Klánská 81/141, 142 00 Prague 4, Czech Republic, IDNo: 00551309

Manufactured: **ORBIT MERRET, spol. s r.o.**
Vodňanská 675/30, 198 00 Prague 9, Czech Republic

declares at its full responsibility that the product presented hereunder meets all technical requirements, is safe for use when utilised under the terms and conditions determined by ORBIT MERRET, spol.s r.o. and that our company has taken all measures to ensure conformity of all products of the type listed hereunder, which are being brought out to the market, with technical documentation and requirements of the appurtenant statutory orders.

Product: 4-digit programmable panel instrument

Type: **OM 402**

Version: UNI, PWR

Conformity is assessed pursuant to the following standards:

El. safety: EN 61010-1
EMC: EN 50131-1, chapter 14 and chapter 15
EN 50130-4, chapter 7 EN 61000-4-11
EN 50130-4, chapter 8 EN 61000-4-11
EN 50130-4, chapter 9 EN 61000-4-2
EN 50130-4, chapter 10 EN 61000-4-3
EN 50130-4, chapter 11 EN 61000-4-6
EN 50130-4, chapter 12 EN 61000-4-4
EN 50130-4, chapter 13 EN 61000-4-5
EN 50130-5, chapter 20
prEN 50131-2-1, par. 9.3.1
EN 61000-4-8
EN 61000-4-9
EN 61000-3-2 ed. 2:2001
EN 61000-3-3: 1997, Cor. 1:1998, Z1:2002
EN 55022, chapter 5 and chapter 6

and Ordinance on:

El. safety: No. 168/1997 Coll.
EMC: No. 169/1997 Coll.

The evidence are the protocols of authorized and accredited organizations:

VTÚE Praha, experimental laboratory No. 1158, accredited by ČIA
VTÚPV Vyškov, experimental laboratory No. 1103, accredited by ČIA

Place and date of issue: Prague, 18. March 2006

Miroslav Hackl v.r.
Company representative

Mode of asses. of conformity §12, par. 4 b, d Act No. 22/1997 Coll.